

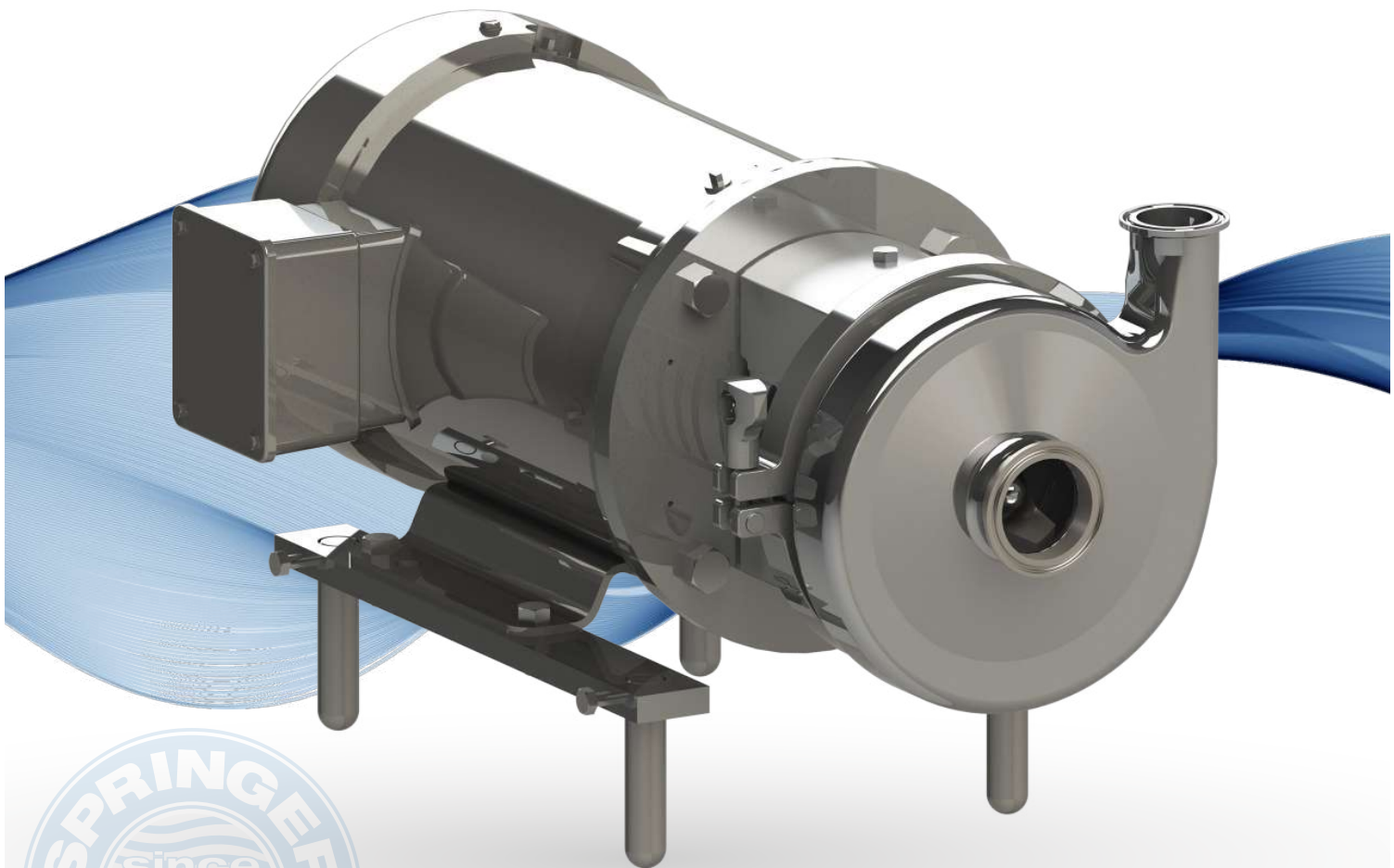

QC/QC+ SERIES



EASY ASSEMBLY CENTRIFUGAL PUMPS



www.qpumps.com

Tel: 866-777-6060
Fax: 866-777-6383

Springer Pumps, LLC

Website: www.springerpumps.com
Int'l: +001 267 404 2910

QC/QC+ SERIES

The QC + series is ideal for sanitary and non-sanitary applications, perfect for the food, beverage and agrochemical industries. They can handle flows of up to 1200 GPM and pressure loads of up to 270 feet. It has the 3-A certification.



Φ	1,200 GPM / 4,542 LPM	μ	up to 600 cP	P	117 psi / 8 bar 270 ft / 82 m	T	120 °C / 248 °F
----------	-----------------------	----------	--------------	----------	----------------------------------	----------	-----------------

CHARACTERISTICS

- Open impeller
- Scroll casing with suction in the center
- Sanitary finish according to standards 3-A certified 1004
- Connections: Clamp (standard), Flange, NPT, Weldable, Bevel Seat, DIN, SMS
- Support set and legs in stainless steel
- Manufactured in NEMA (American) and IEC (European) standards
- They can work in both 60 Hz and 50 Hz
- Stainless steel adapter
- All the parts in contact with the product are made of T316L stainless steel



EJEMPLO QC-216-M-D-ARMAZÓN / EXAMPLE QC-216-M-D-FRAME

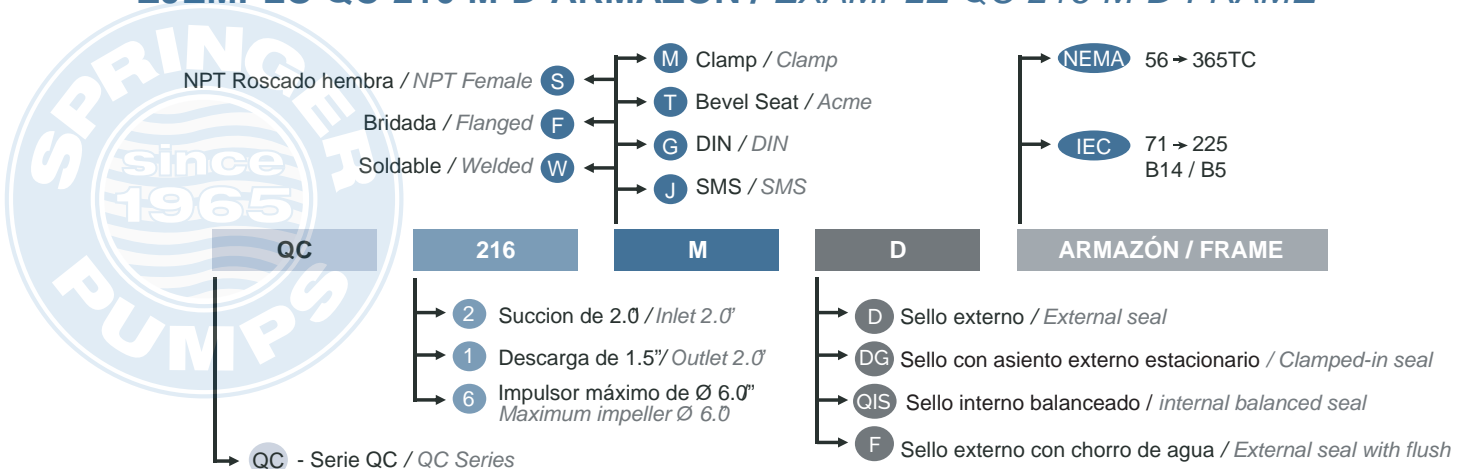

QUALITY UNDER INTERNATIONAL STANDARDS

“D” TYPE SEAL - Balanced External Seal

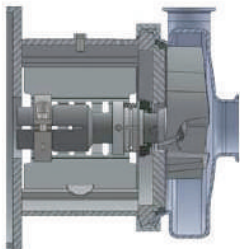

Applicable to a wide variety of uses, this seal is designed to have a long service life.

Applications: dairy products, corn oils, tomato juice, drinks, water, etc. It is also useful for acidic cleaning solutions and detergents.

It is not recommended for applications where the product is abrasive, corrosive or that when drying forms layers. It can also be combined with the water jet to prolong its life, becoming the “F” type seal.

SEAL TYPE “DG” - Stationary External Seat

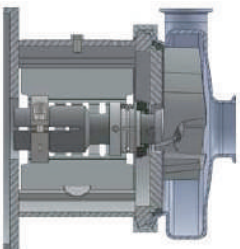

This long-life seal uses standard rotary components of the D seal, plus a stationary element to be selected from materials such as silicon carbide, ceramic and tungsten carbide.

Applications of liquid sugar, abrasive and corrosive products such as acids or caustic soda, as long as it is used with the correct elastomers.

It can be combined with the water jet to prolong its life.

QC+ SERIES

- The QC + series is an exclusive Q-Pumps design that complies with 3-A sanitary standards
- Facilitates and streamlines the assembly of QC series pumps
- Better support of the impeller by means of a wedge and a nut
- Greater long-term efficiency
- A normal pump of the QC series can be converted to the QC plus series with a Kit plus



QC/QC+ SERIES

EASY ASSEMBLY CENTRIFUGAL PUMPS

*Curves for reference

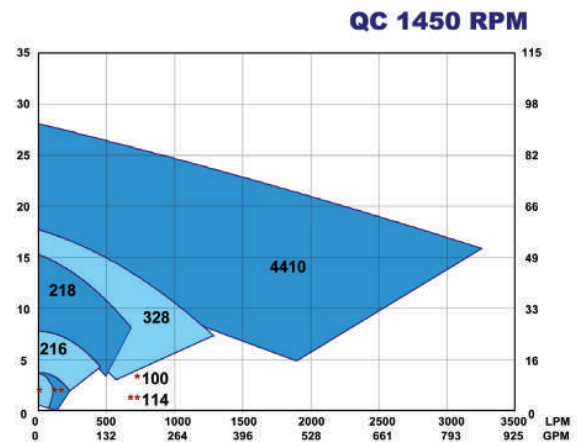
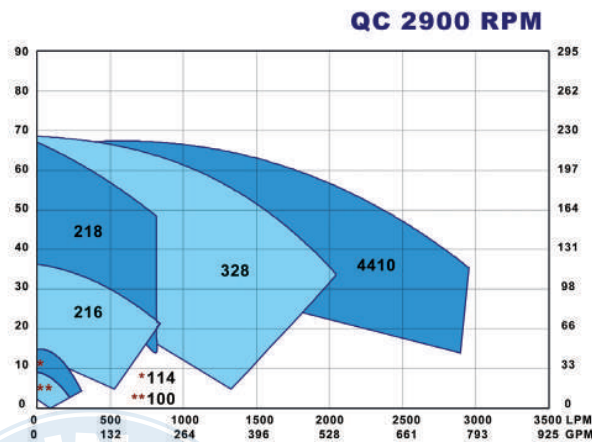
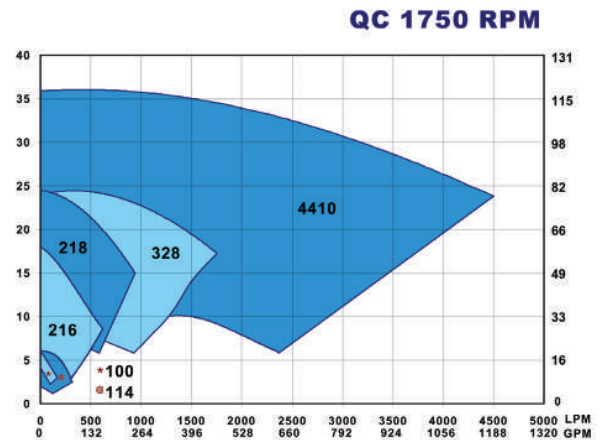
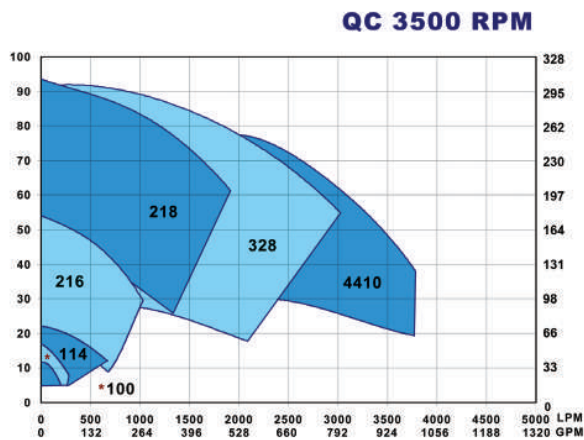

Distributed by:

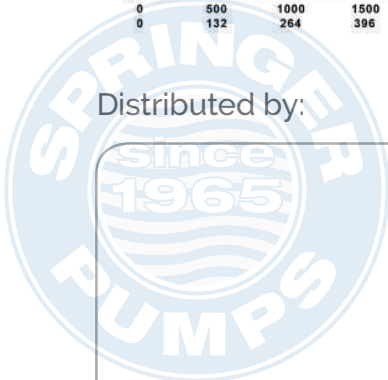

For more information visit:

www.qpumps.com

or call us at +52 (442) 103 31 00

Tel: 866-777-6060
Fax: 866-777-6383

Springer Pumps, LLC

Website: www.springerpumps.com
Int'l: +001 267 404 2910