

QP1 Series - Positive displacement pumps

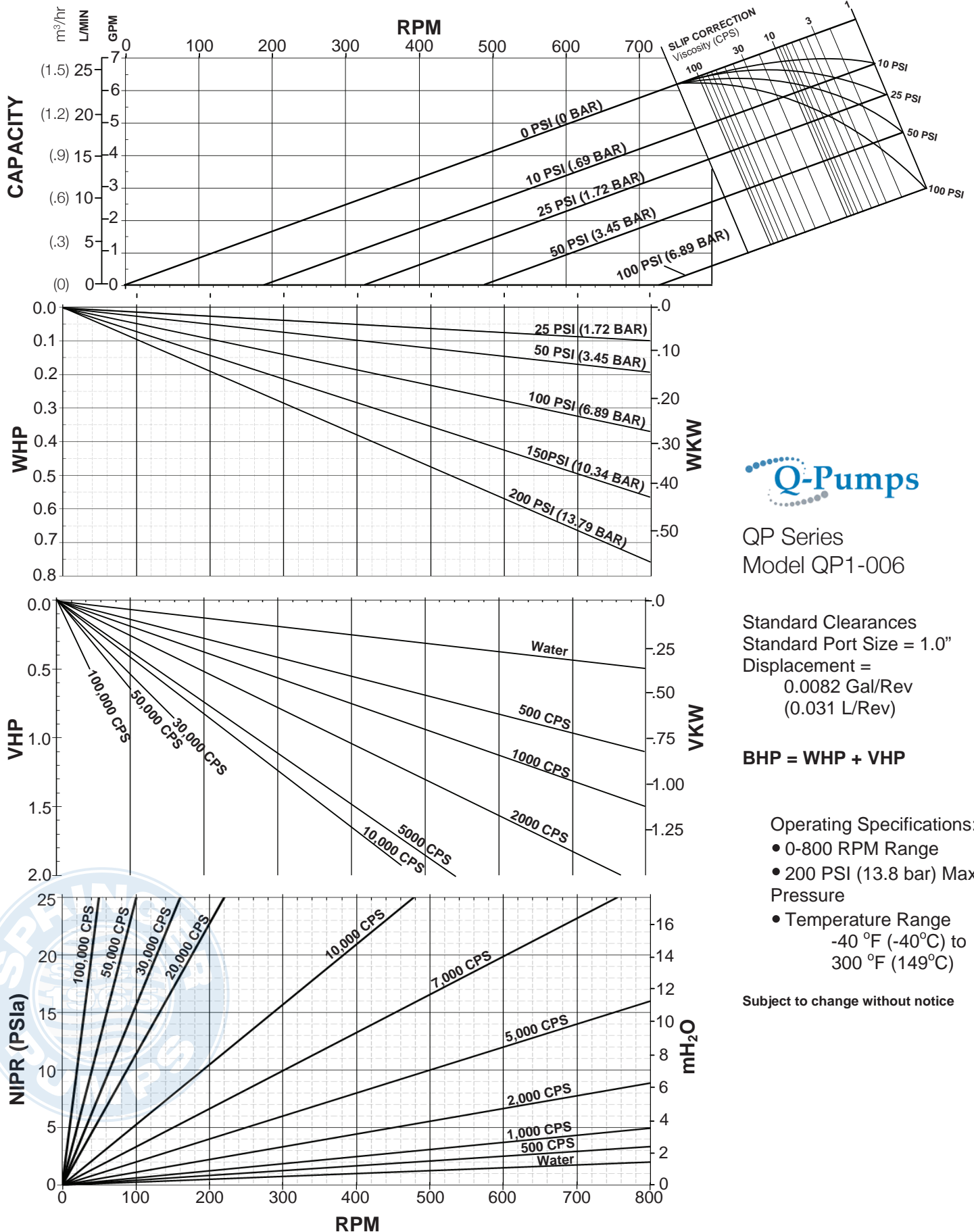

QP Series
Model QP1-006

Standard Clearances
Standard Port Size = 1.0"
Displacement =
0.0082 Gal/Rev
(0.031 L/Rev)

BHP = WHP + VHP

- Operating Specifications:
- 0-800 RPM Range
 - 200 PSI (13.8 bar) Max. Pressure
 - Temperature Range
-40 °F (-40°C) to
300 °F (149°C)

Subject to change without notice

QP1 Series - Positive displacement pumps

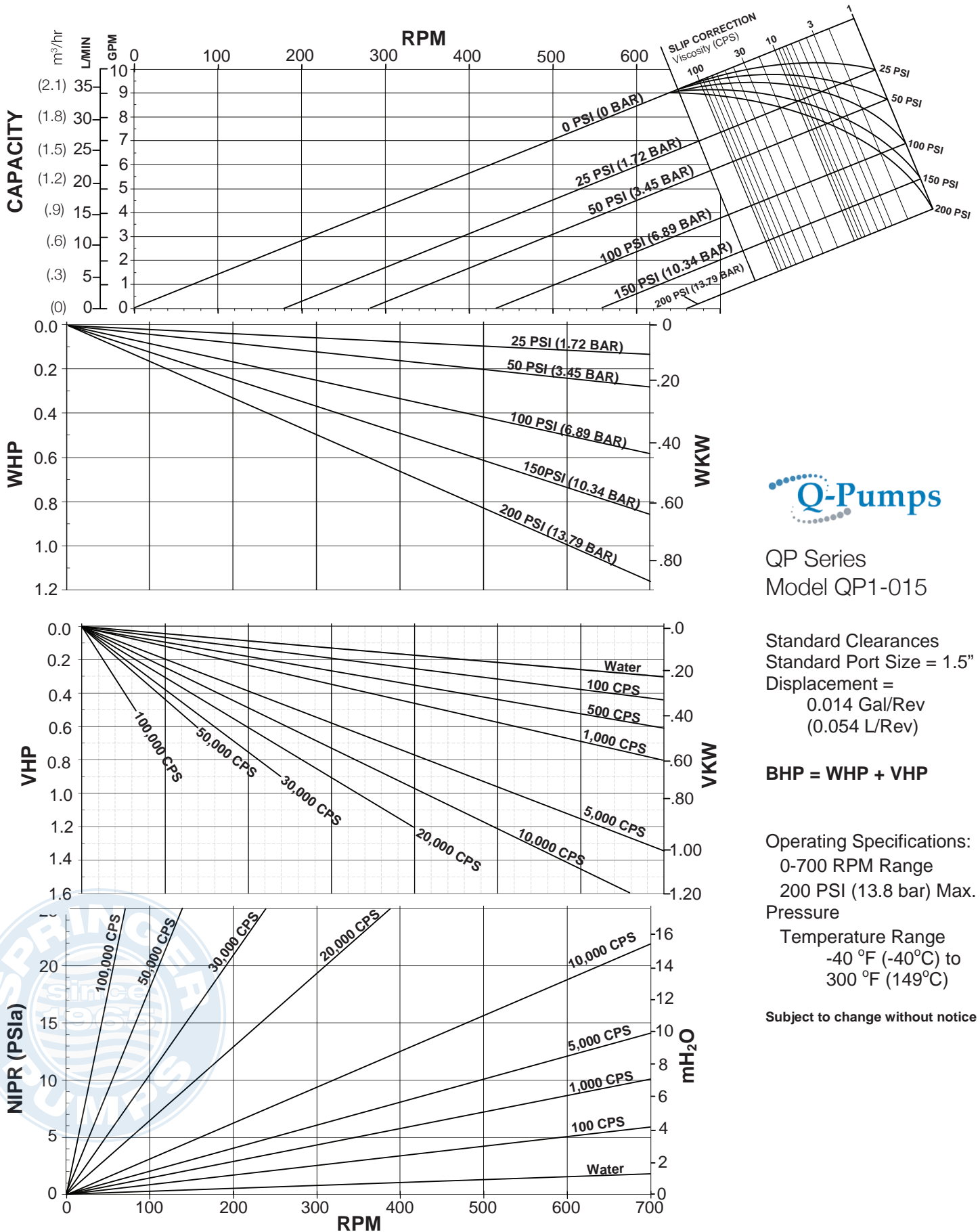

QP Series
Model QP1-015

Standard Clearances
Standard Port Size = 1.5"
Displacement =
0.014 Gal/Rev
(0.054 L/Rev)

BHP = WHP + VHP

Operating Specifications:
0-700 RPM Range
200 PSI (13.8 bar) Max. Pressure
Temperature Range
-40 °F (-40°C) to
300 °F (149°C)

Subject to change without notice

QP1 Series - Positive displacement pumps

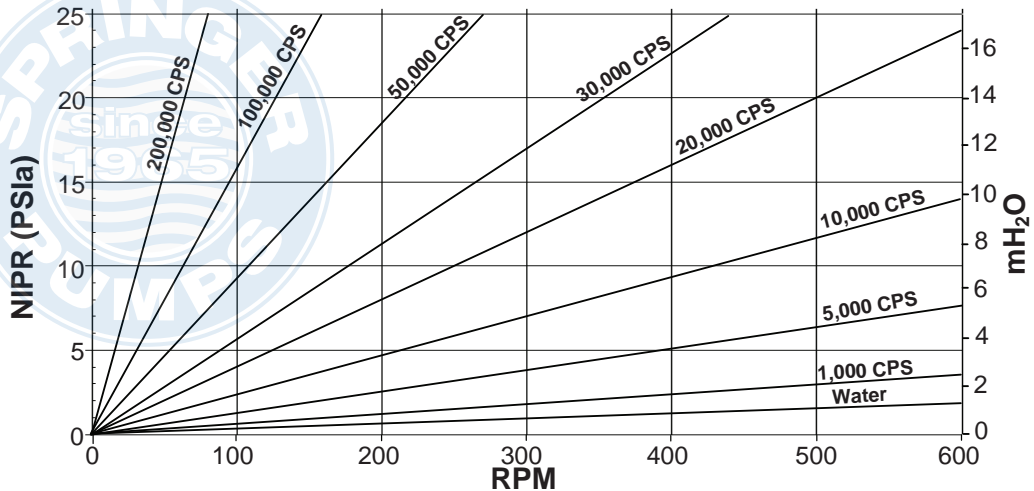
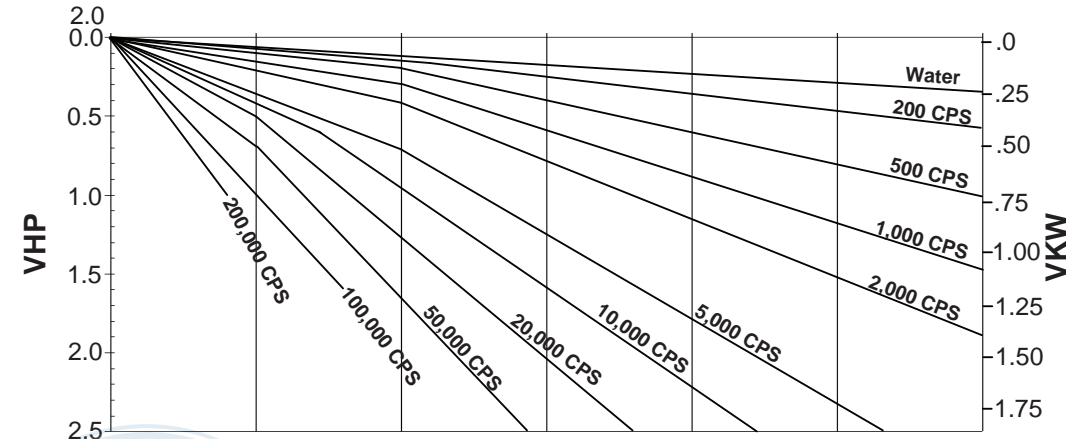
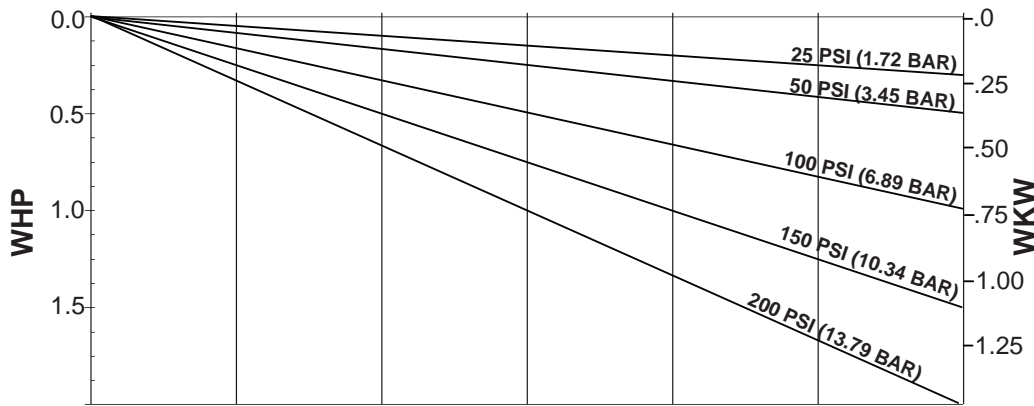
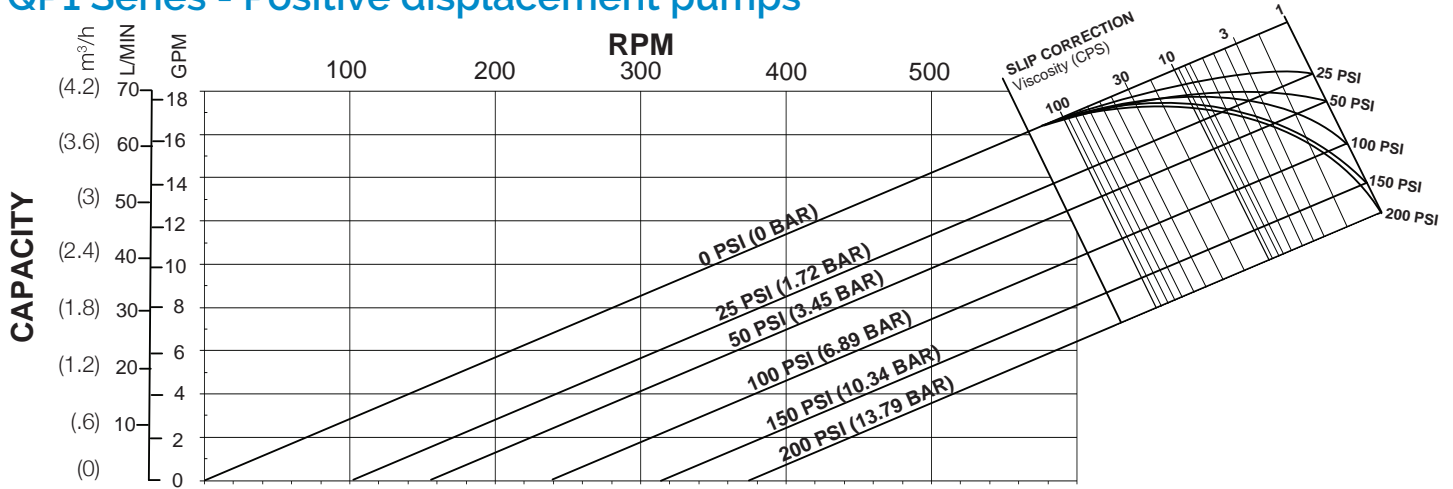

QP Series
Model QP1-018

Standard Clearances
Standard Port Size = 1.5"
Displacement =
0.029 Gal/Rev
(0.108 L/Rev)

BHP = WHP + VHP

- Operating Specifications:
- 0-600 RPM Range
 - 200 PSI (13.8 bar) Max. Pressure
 - Temperature Range
-40 °F (-40°C) to
300 °F (149°C)

Subject to change without notice

QP1 Series - Positive displacement pumps

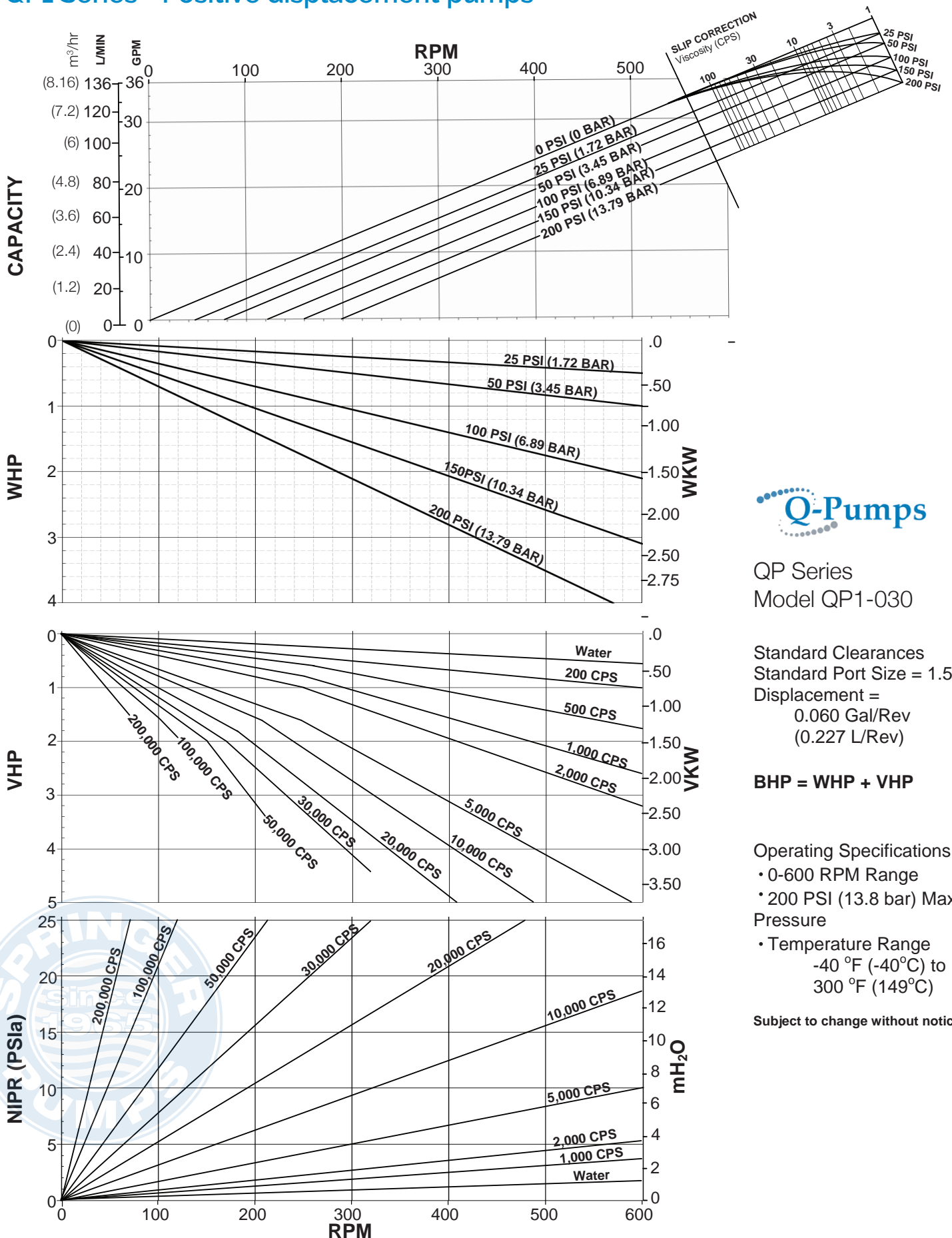

QP Series
Model QP1-030

Standard Clearances
Standard Port Size = 1.5"
Displacement =
0.060 Gal/Rev
(0.227 L/Rev)

BHP = WHP + VHP

- Operating Specifications:
- 0-600 RPM Range
 - 200 PSI (13.8 bar) Max. Pressure
 - Temperature Range
-40 °F (-40°C) to
300 °F (149°C)

Subject to change without notice

QP1 Series - Positive displacement pumps

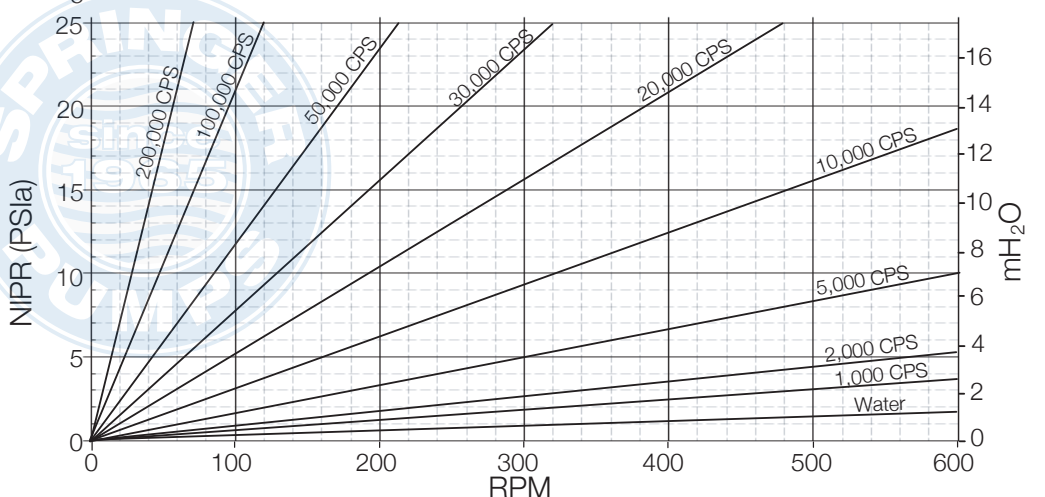
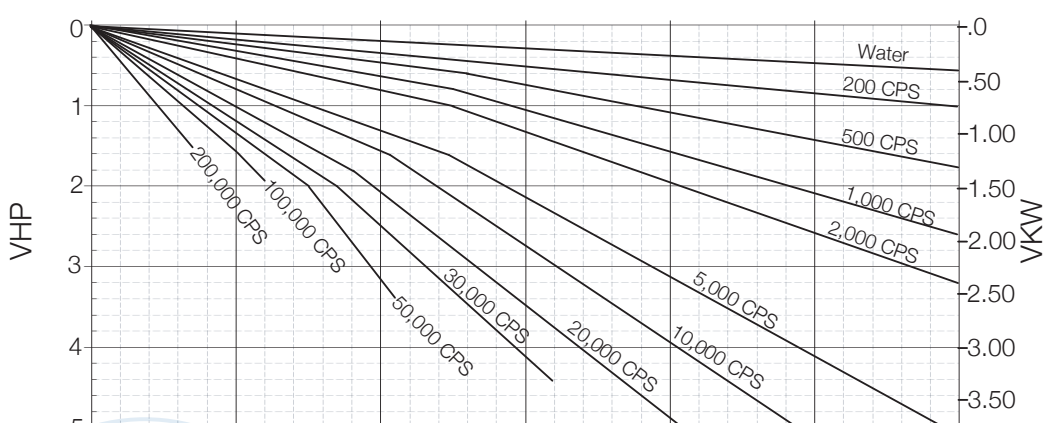
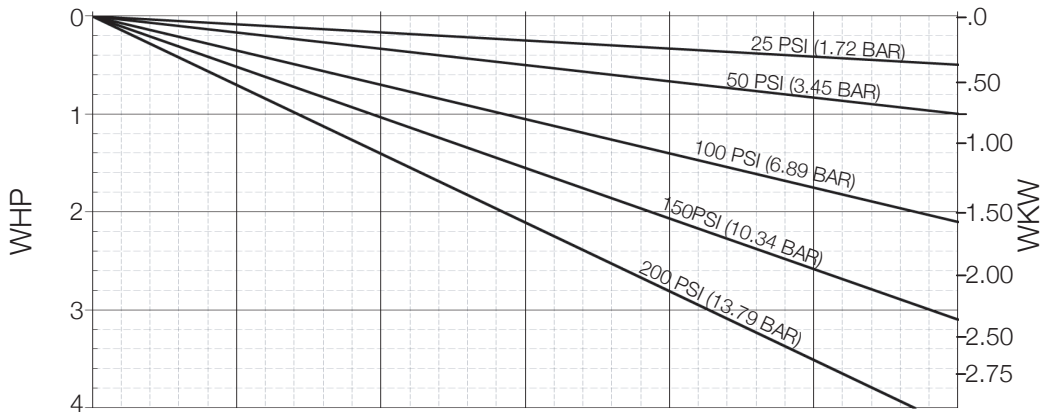
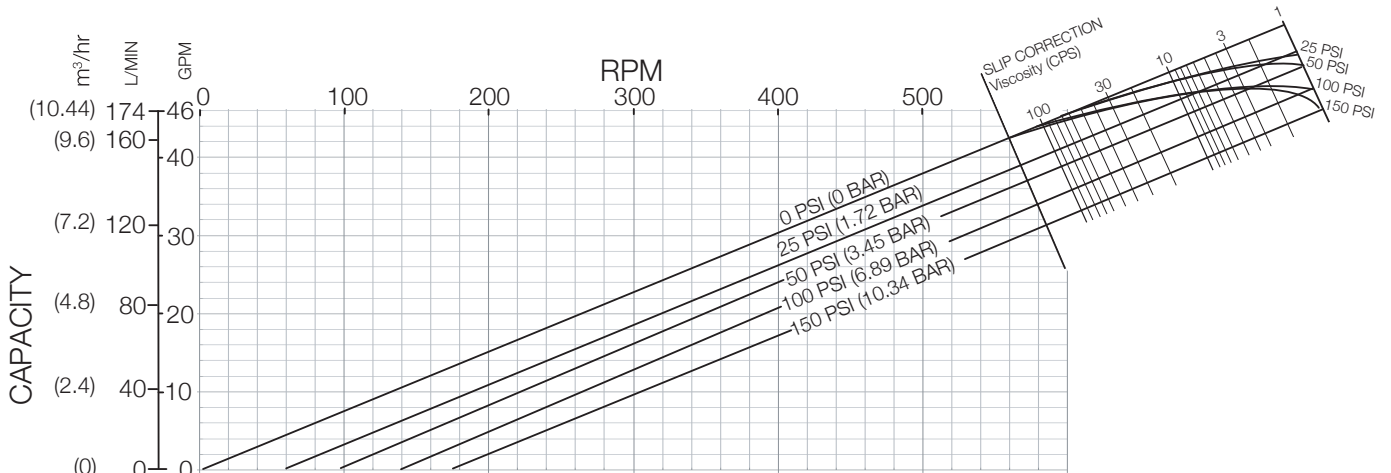

QP Series
Model QP1-040

Standard Clearances
Standard Port Size = 2.0"
Displacement =
0.076Gal/Rev
(0.288 L/Rev)

BHP = WHP + VHP

- Operating Specifications:
- 0-600 RPM Range
 - 150 PSI (10.3 bar) Max. Pressure
 - Temperature Range
-40 °F (-40°C) to
300 °F (149 °C)

Subject to change without notice

QP1 Series - Positive displacement pumps

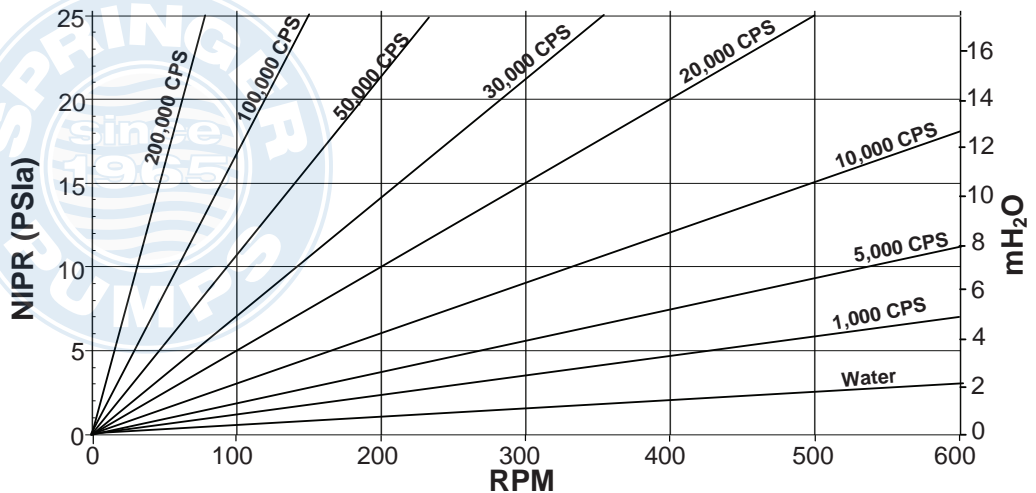
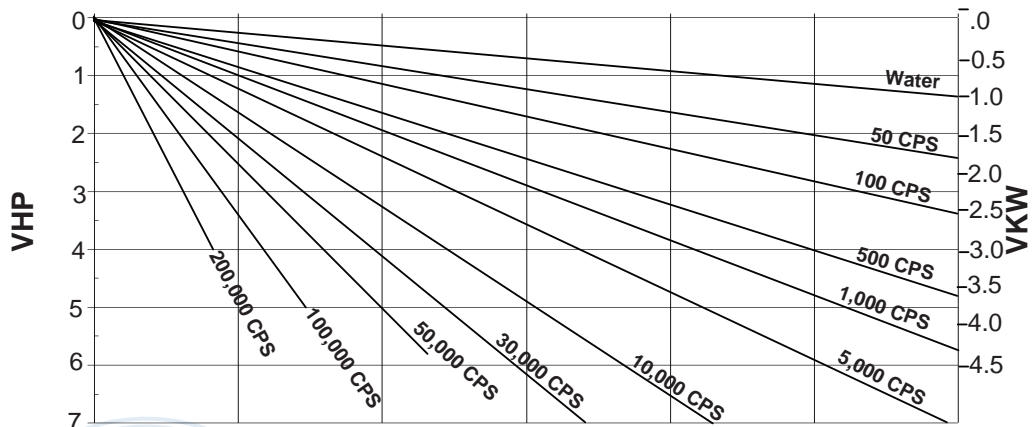
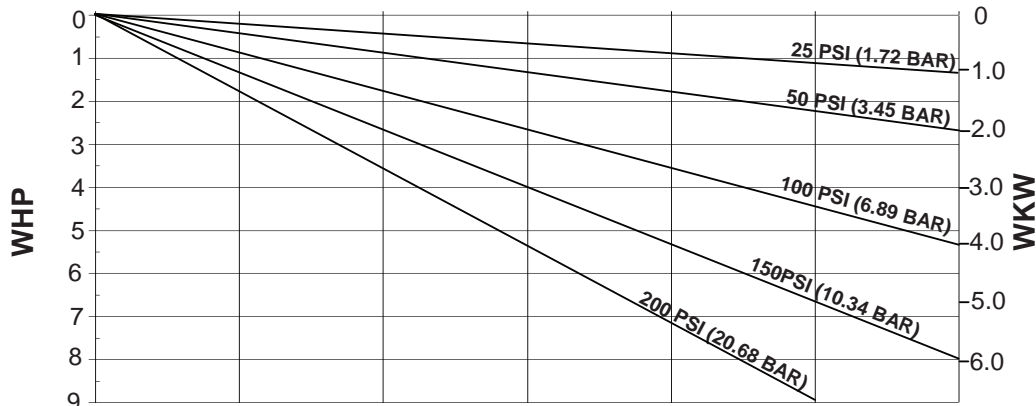
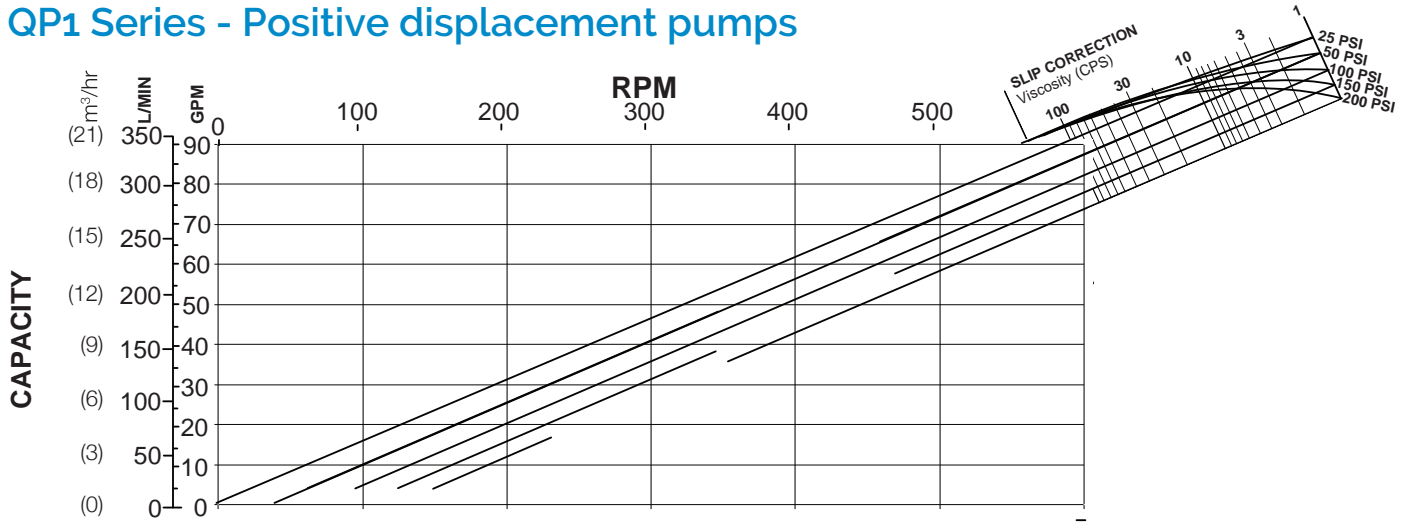

QP Series
Model QP1-060

Standard Clearances
Standard Port Size = 2.5"
Displacement =
0.153 Gal/Rev
(0.579 L/Rev)

BHP = WHP + VHP

- Operating Specifications:
- 0-600 RPM Range
 - 200 PSI (13.8 bar) Max. Pressure
 - Temperature Range
-40 °F (-40°C) to
300 °F (149°C)

Subject to change without notice

QP1 Series - Positive displacement pumps

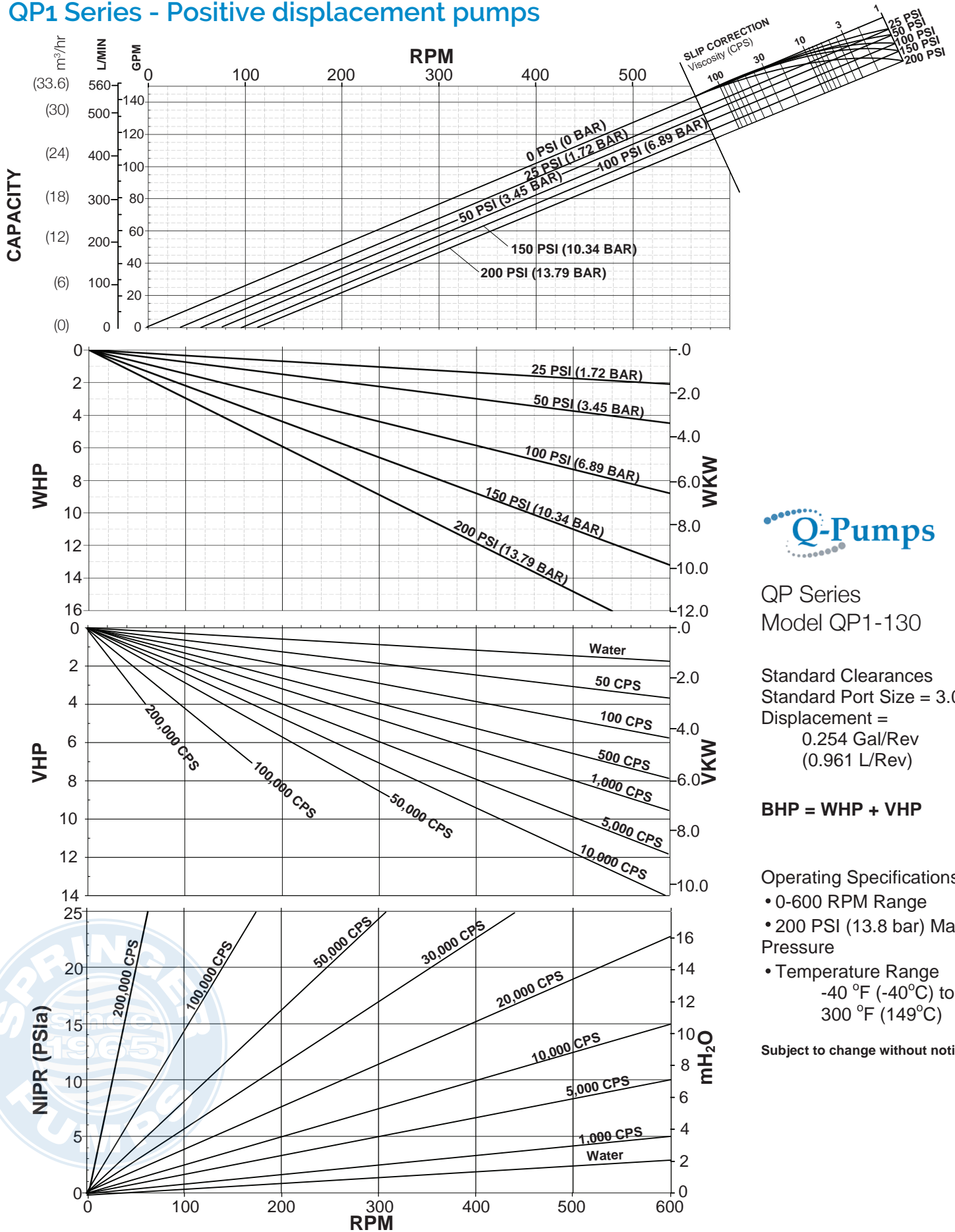

QP Series
Model QP1-130

Standard Clearances
Standard Port Size = 3.0"
Displacement =
0.254 Gal/Rev
(0.961 L/Rev)

BHP = WHP + VHP

- Operating Specifications:
- 0-600 RPM Range
 - 200 PSI (13.8 bar) Max. Pressure
 - Temperature Range
-40 °F (-40°C) to
300 °F (149°C)

Subject to change without notice

QP1 Series - Positive displacement pumps

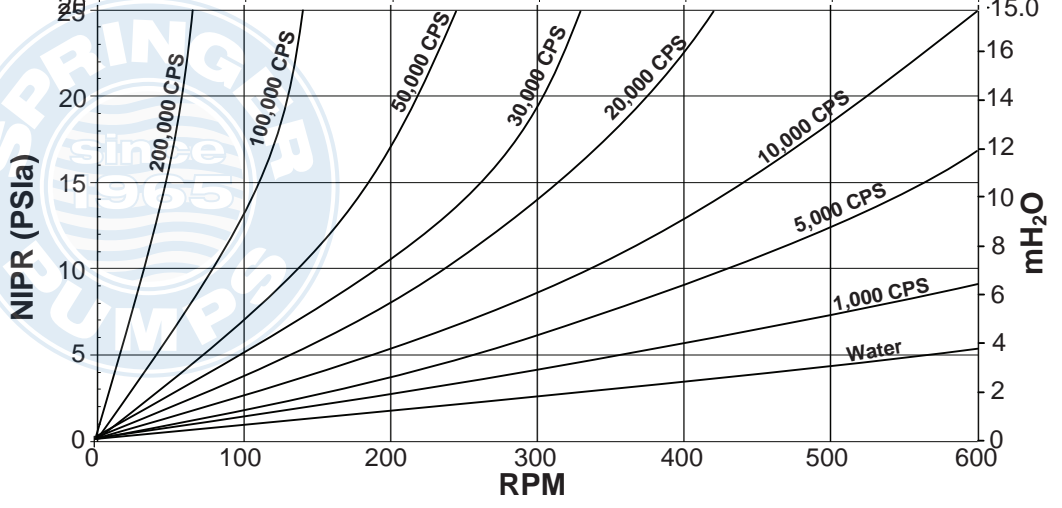
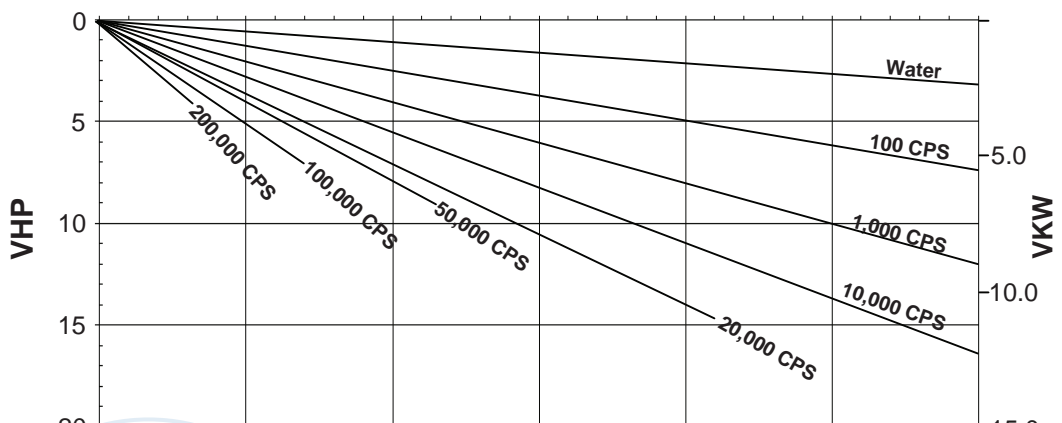
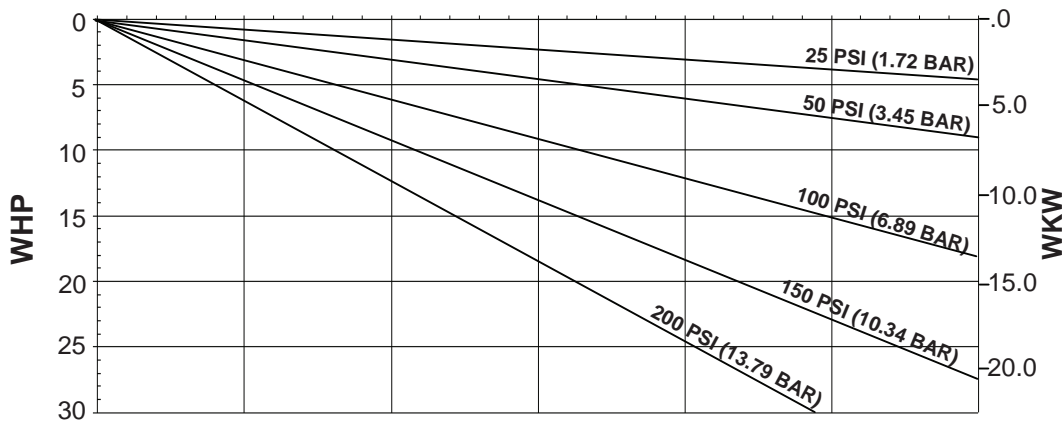
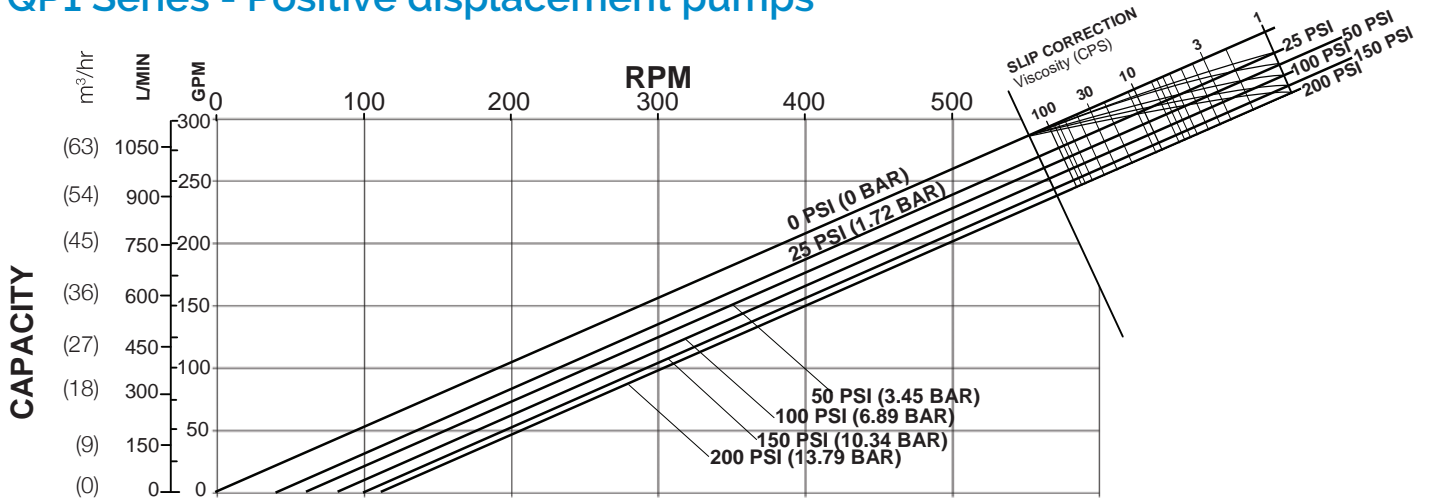

QP Series
Model QP1-220

Standard Clearances
Standard Port Size = 4.0"
Displacement =
0.522 Gal/Rev
(1.976 L/Rev)

BHP = WHP + VHP

Operating Specifications:
0-600 RPM Range
200 PSI (13.8 bar) Max.
Pressure
Temperature Range
-40 °F (-40°C) to
300 °F (149°C)

Subject to change without notice

QP1 Series - Positive displacement pumps

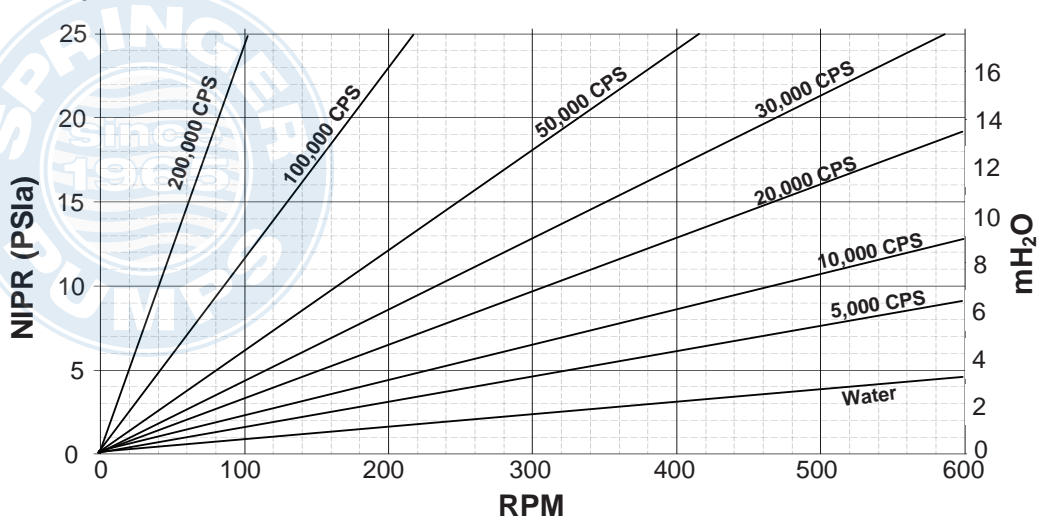
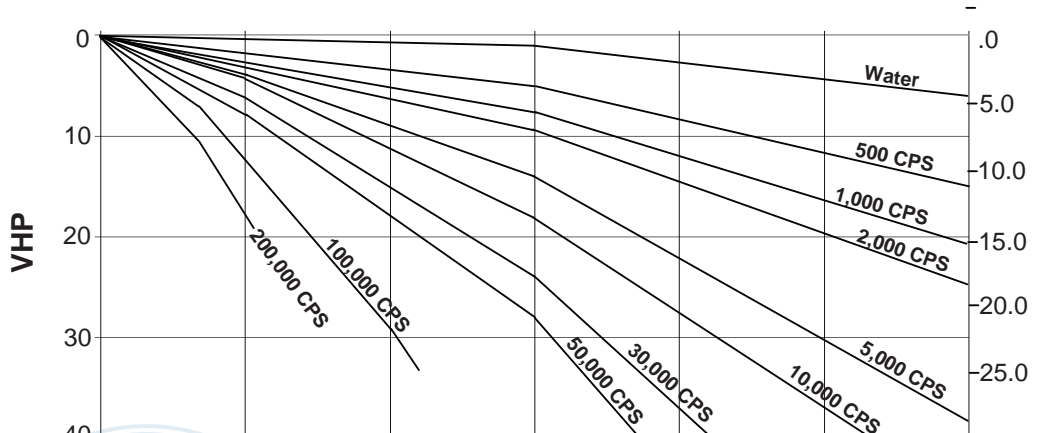
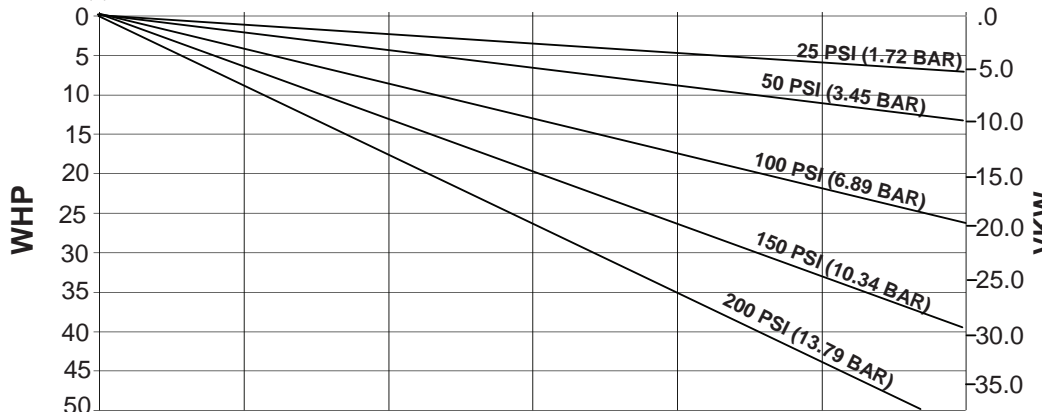
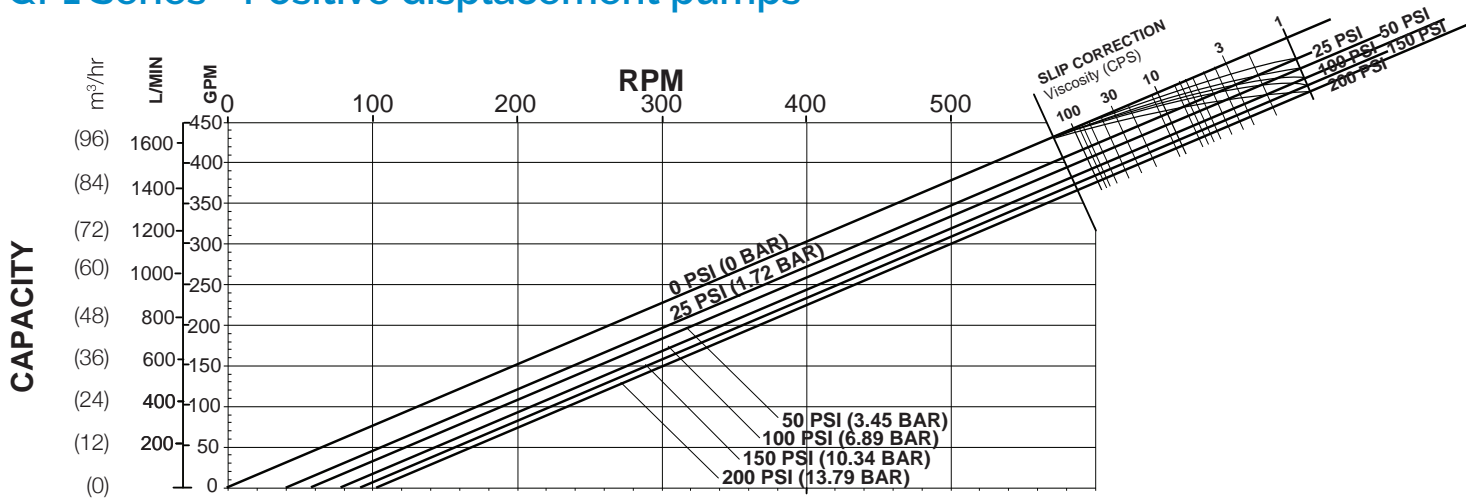

QP Series
Model QP1-320

Standard Clearances
Standard Port Size = 6.0"
Displacement =
0.754 Gal/Rev
(2.854 L/Rev)

BHP = WHP + VHP

Operating Specifications:
0-600 RPM Range
200 PSI (13.8 bar) Max. Pressure
Temperature Range
-40 °F (-40°C) to
300 °F (149°C)

Subject to change without notice

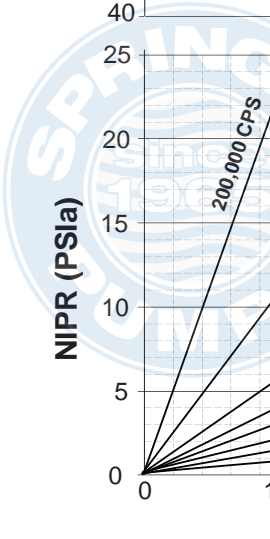

QP2 Series - Positive displacement pumps

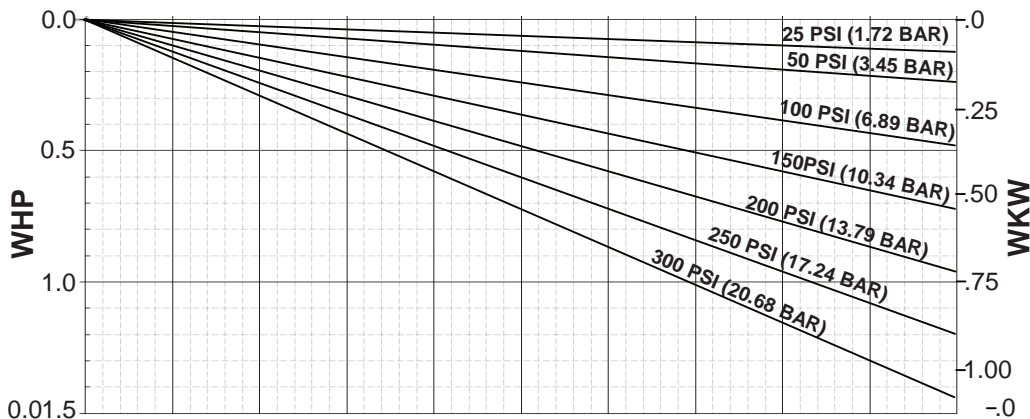
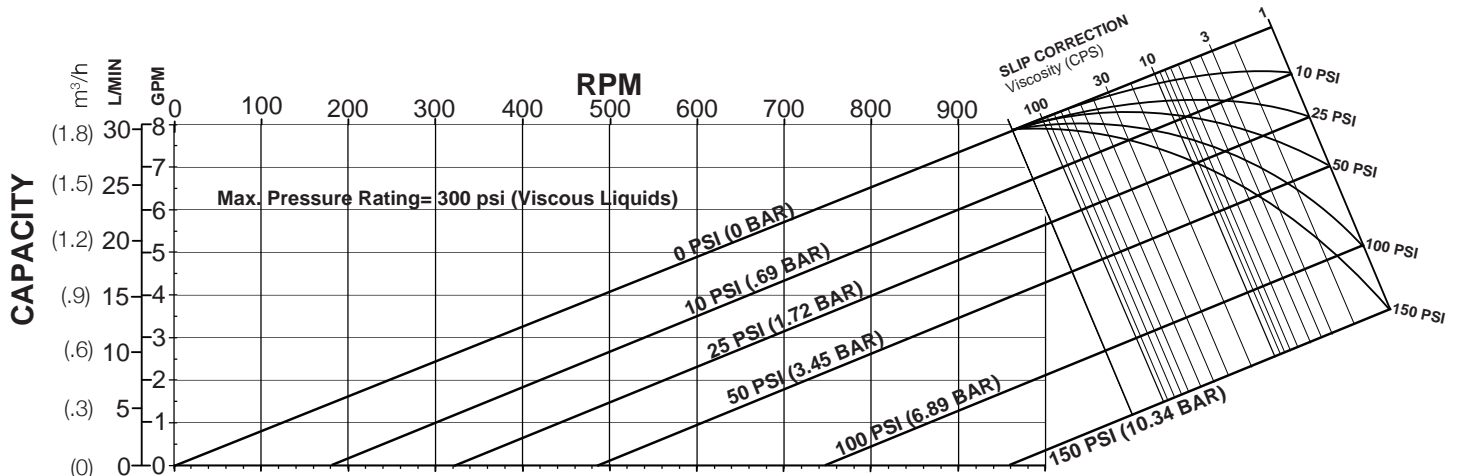

QP Series
Model QP2-006

Standard Clearances
Standard Port Size = 1.0"
Displacement =
0.0082 Gal/Rev
(0.031 L/Rev)

BHP = WHP + VHP

Operating Specifications:
0-1000 RPM Range
300 PSI (20.7 bar) Max. Pressure
Temperature Range
-40 °F (-40°C) to
300 °F (149°C)

Subject to change without notice

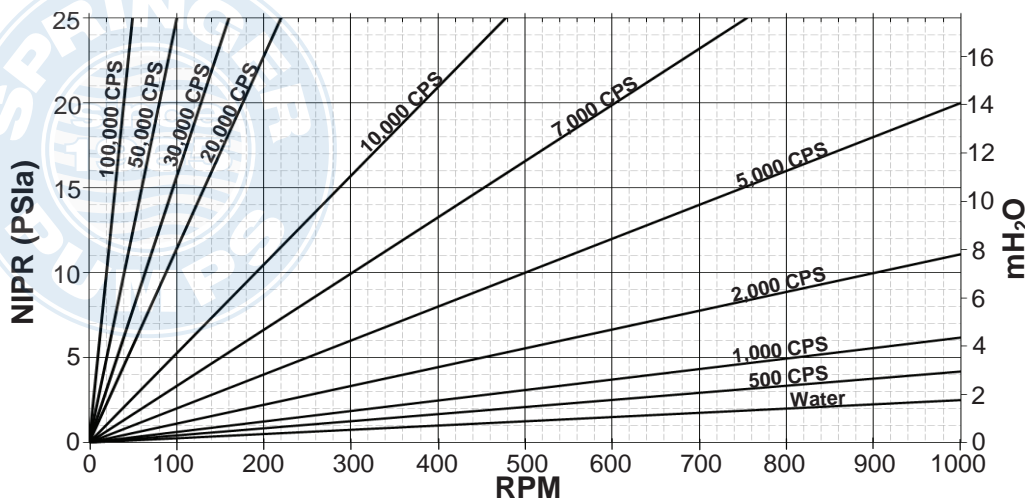
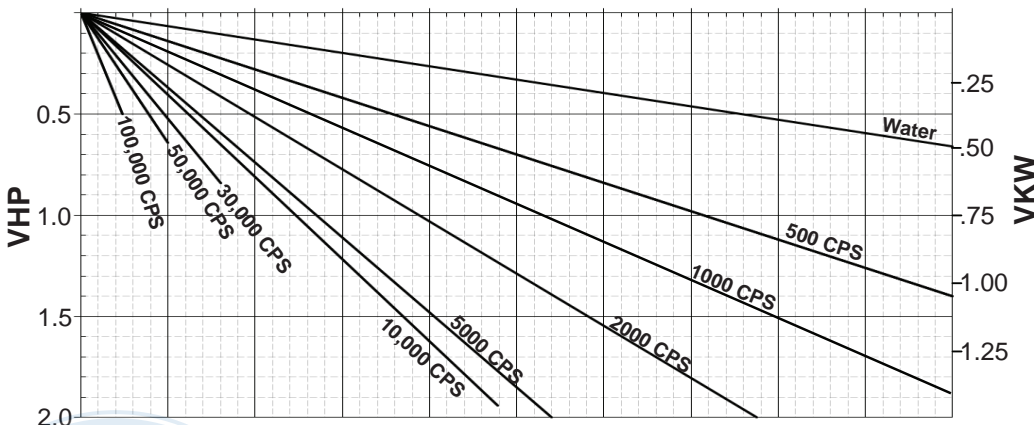

QP2 Series - Positive displacement pumps

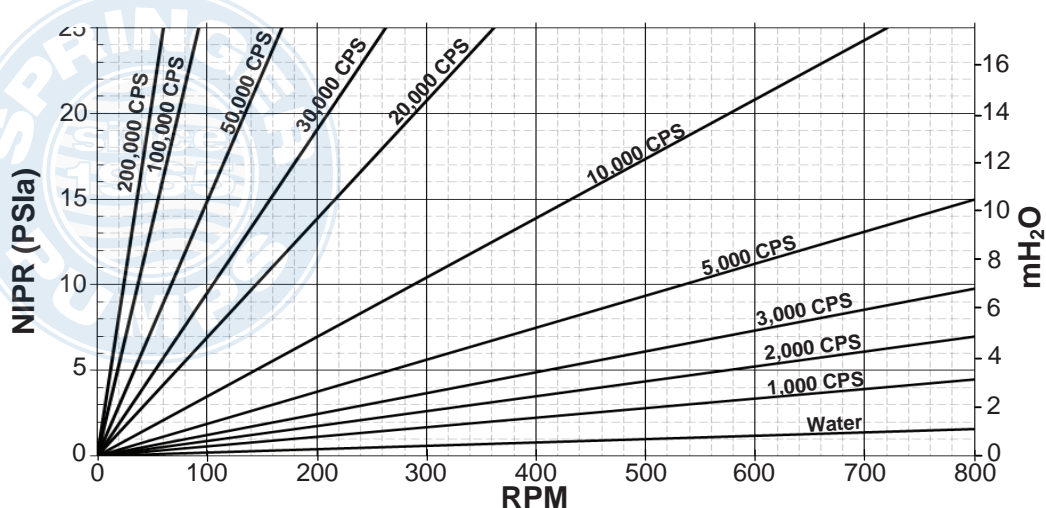
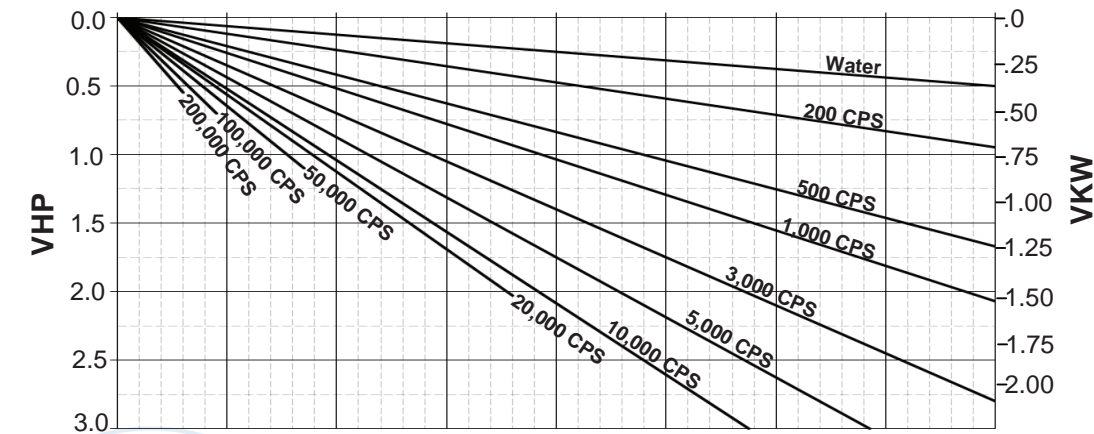
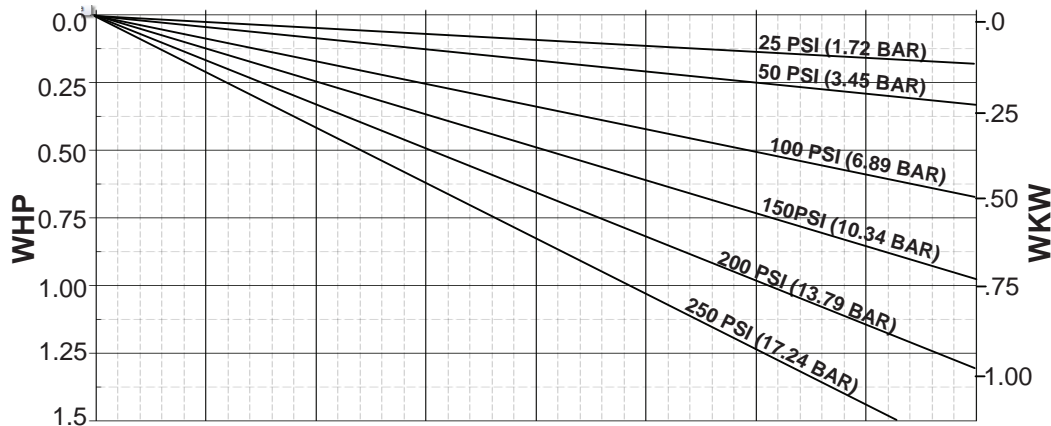
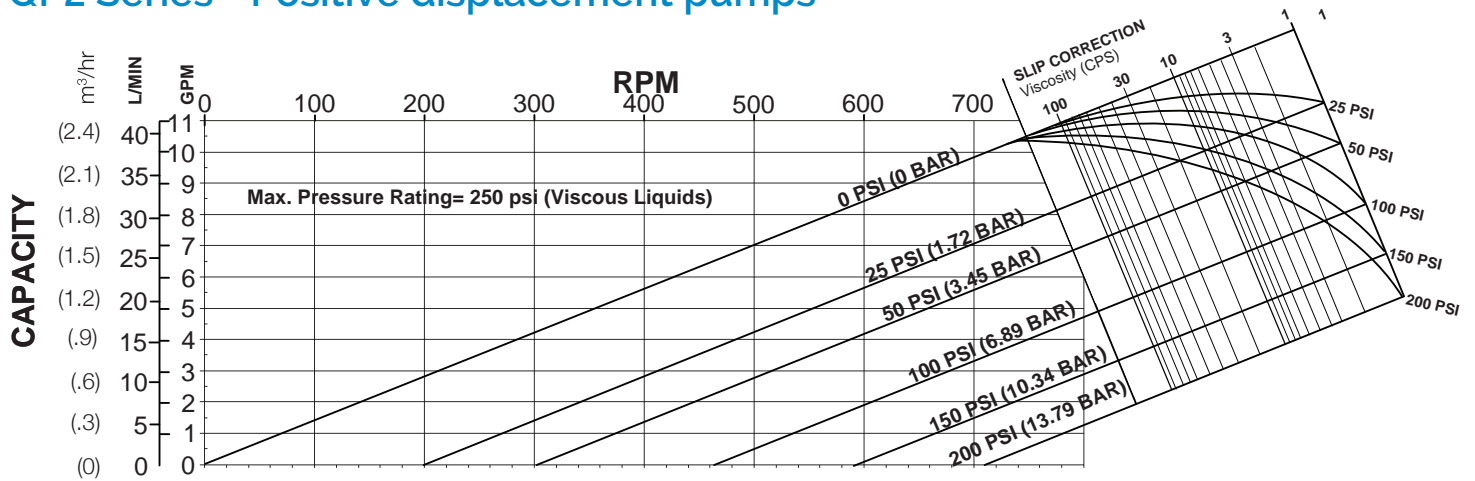

QP Series
Model QP2-015

Standard Clearances
Standard Port Size = 1.5"
Displacement =
0.014 Gal/Rev
(0.054 L/Rev)

BHP = WHP + VHP

Operating Specifications:
0-800 RPM Range
250 PSI (17.2 bar) Max. Pressure

Temperature Range
-40 °F (-40°C) to
300 °F (149°C)

Subject to change without notice

QP2 Series - Positive displacement pumps

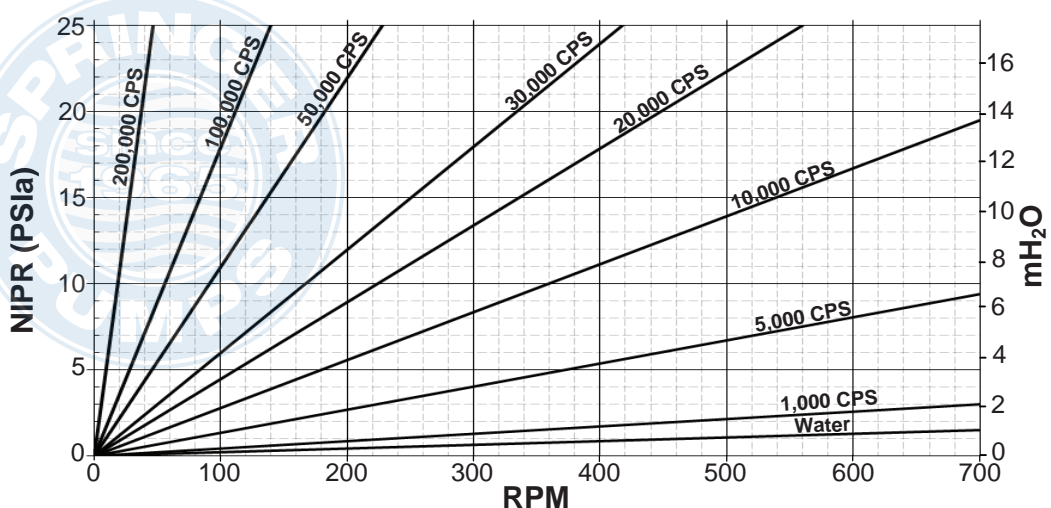
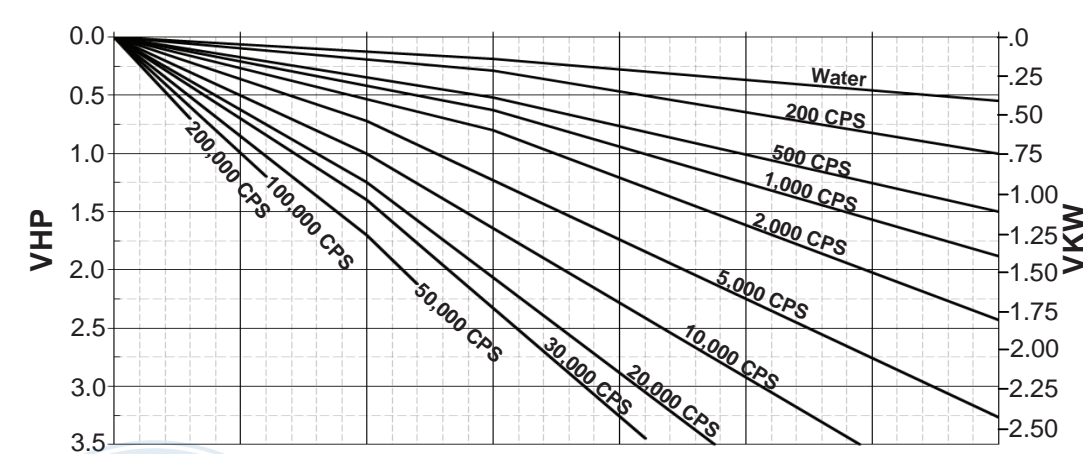
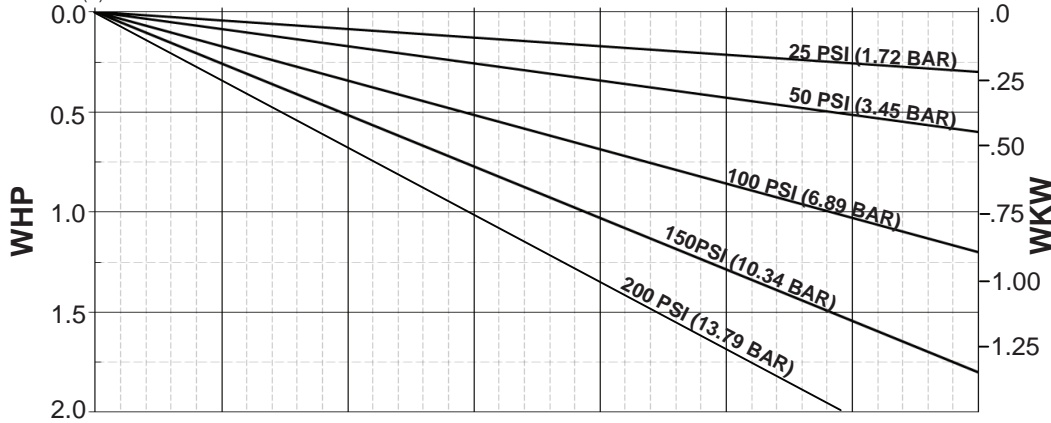
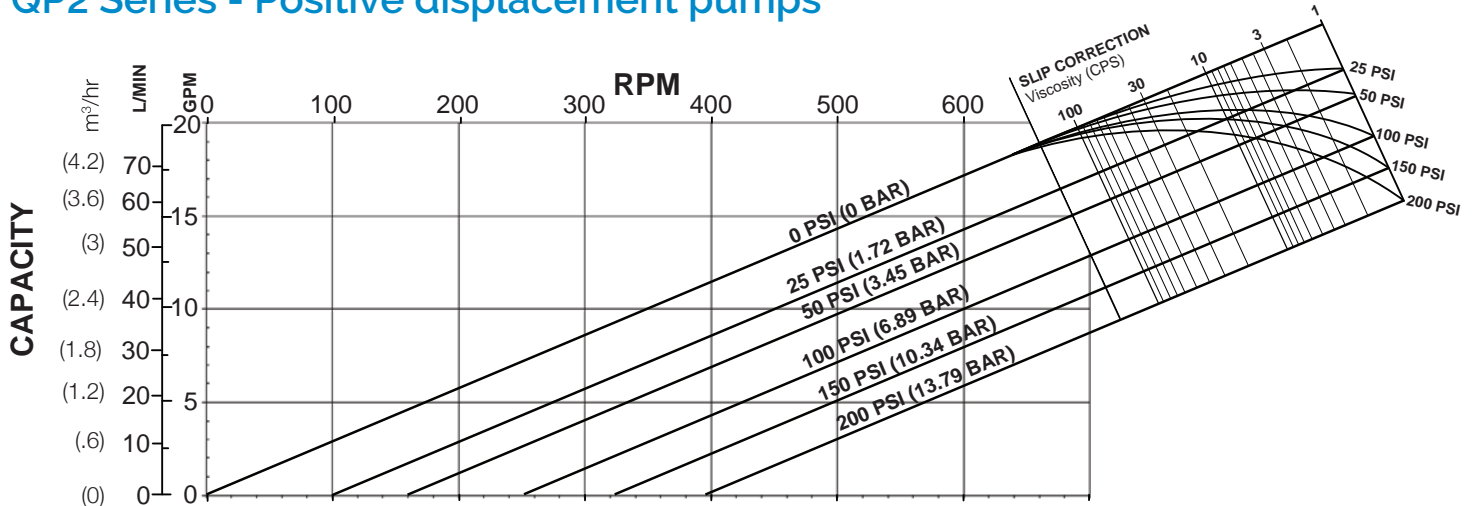

QP Series
Model QP2-018

Standard Clearances
Standard Port Size = 1.5"
Displacement =
0.029 Gal/Rev
(0.108 L/Rev)

BHP = WHP + VHP

Operating Specifications:
0-700 RPM Range
200 PSI (13.8 bar) Max. Pressure
Temperature Range
-40 °F (-40°C) to
300 °F (149°C)

Subject to change without notice

QP2 Series - Positive displacement pumps

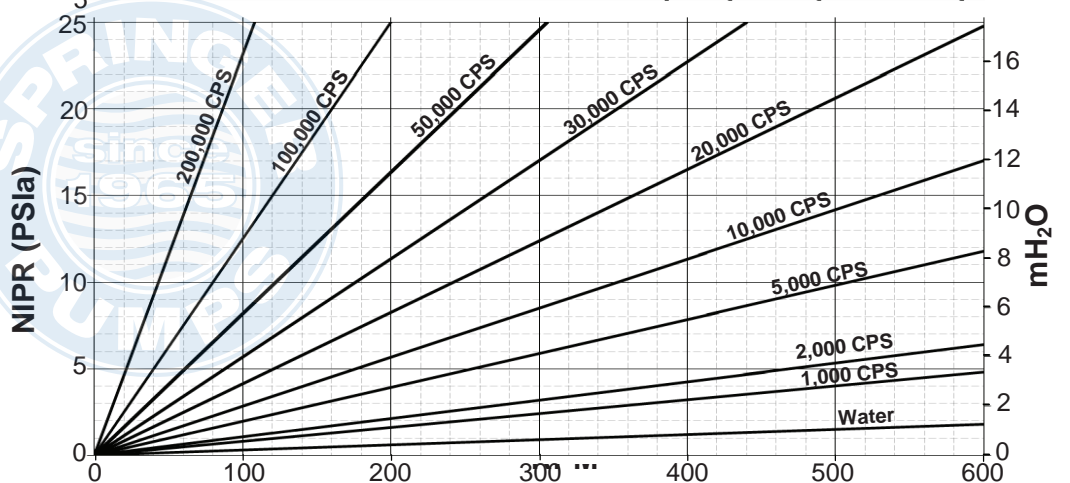
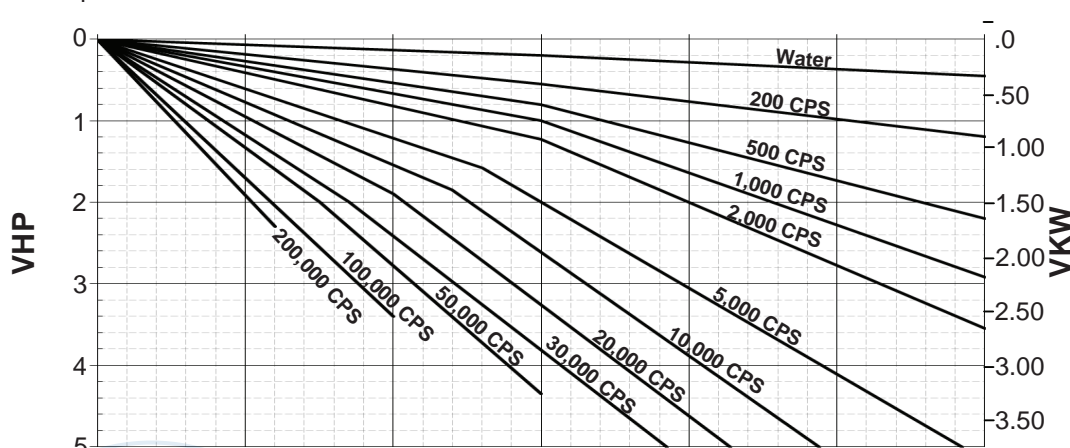
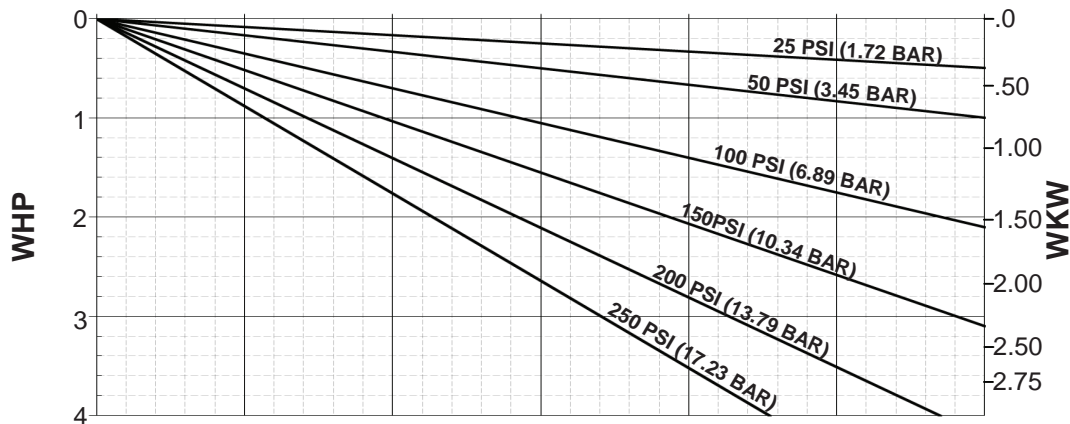
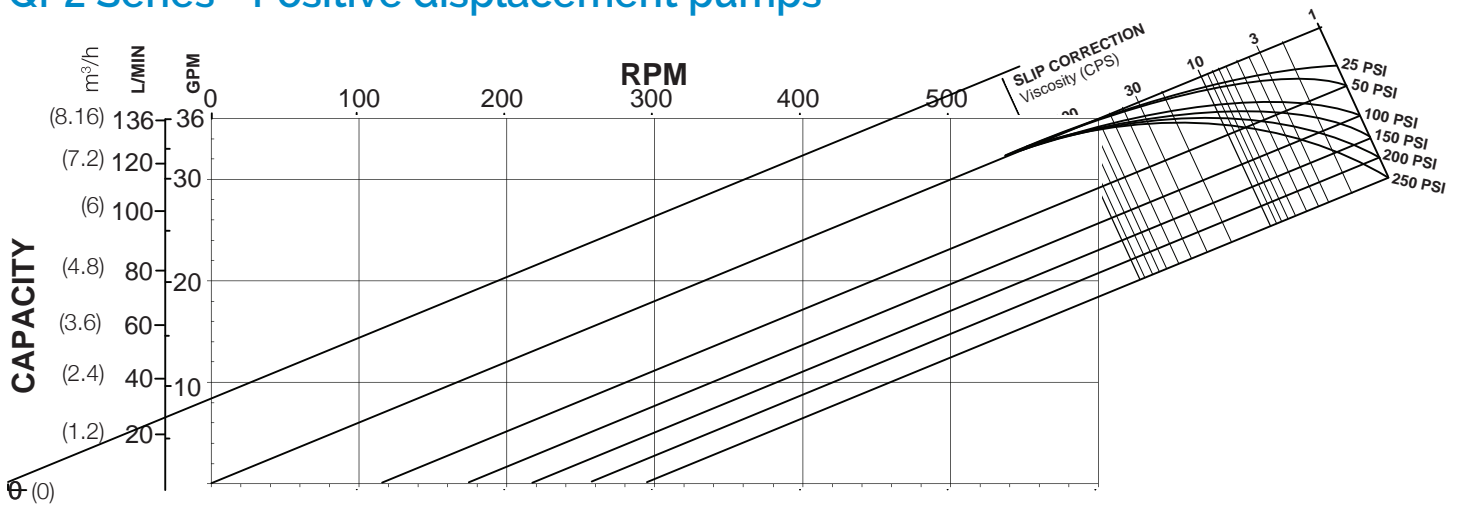

QP Series
Model QP2-030

Standard Clearances
Standard Port Size = 1.5"
Displacement =
0.060 Gal/Rev
(0.227 L/Rev)

BHP = WHP + VHP

Operating Specifications:
0-600 RPM Range
250 PSI (17.2 bar) Max. Pressure
Temperature Range
-40 °F (-40°C) to
300 °F (149°C)

Subject to change without notice

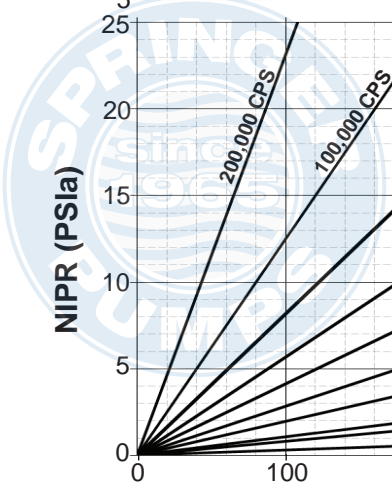

QP2 Series - Positive displacement pumps

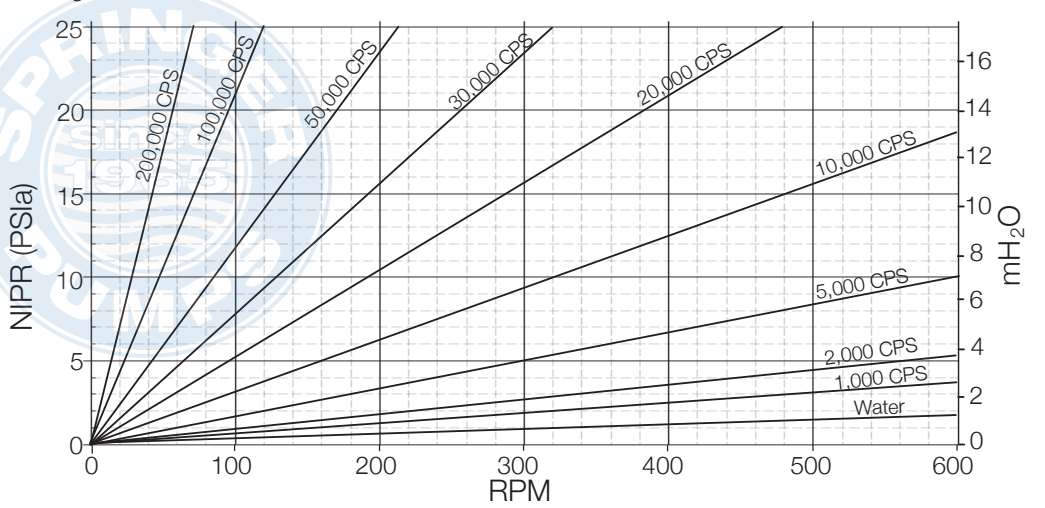
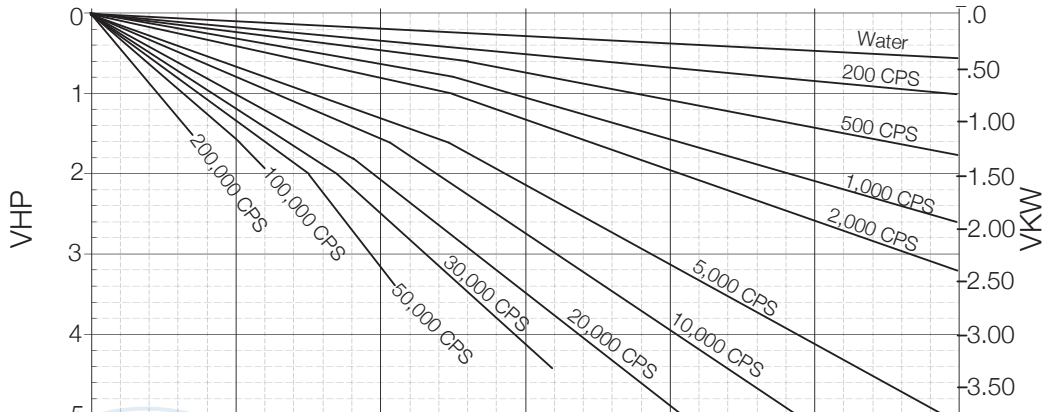
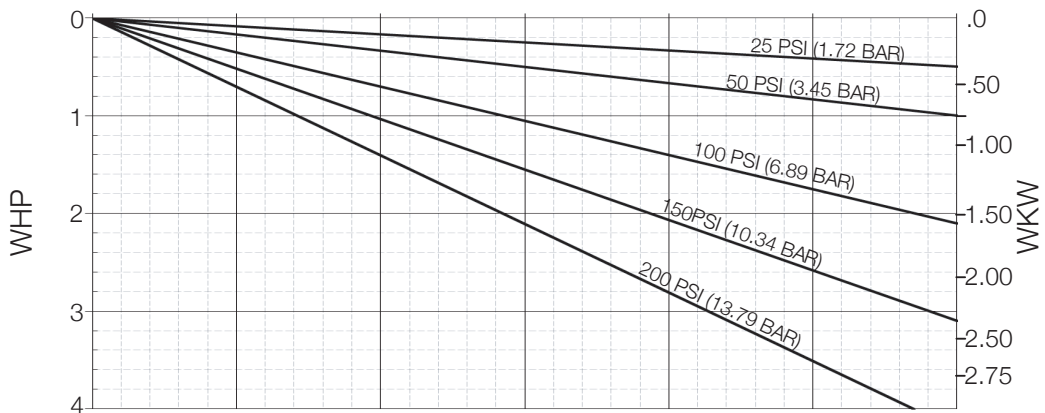
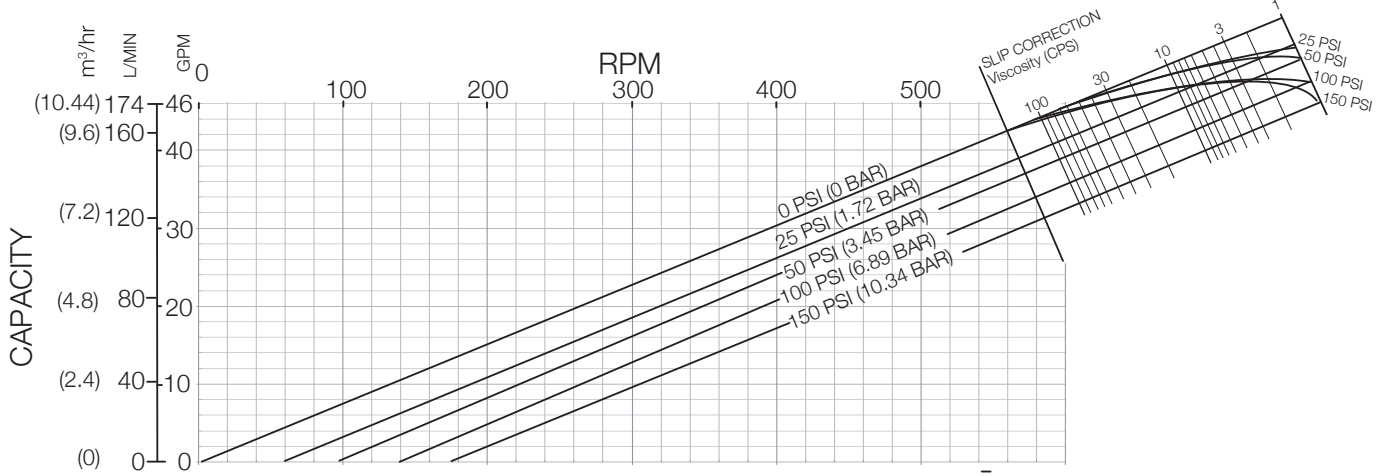

QP Series
Model QP2-040

Standard Clearances
Standard Port Size = 2.0"
Displacement =
0.076Gal/Rev
(0.288 L/Rev)

BHP = WHP + VHP

Operating Specifications:
0-600 RPM Range
150 PSI (10.3 bar) Max.
Pressure
Temperature Range
-40 °F (-40°C) to
300 °F (149 °C)

Subject to change without notice

QP2 Series - Positive displacement pumps

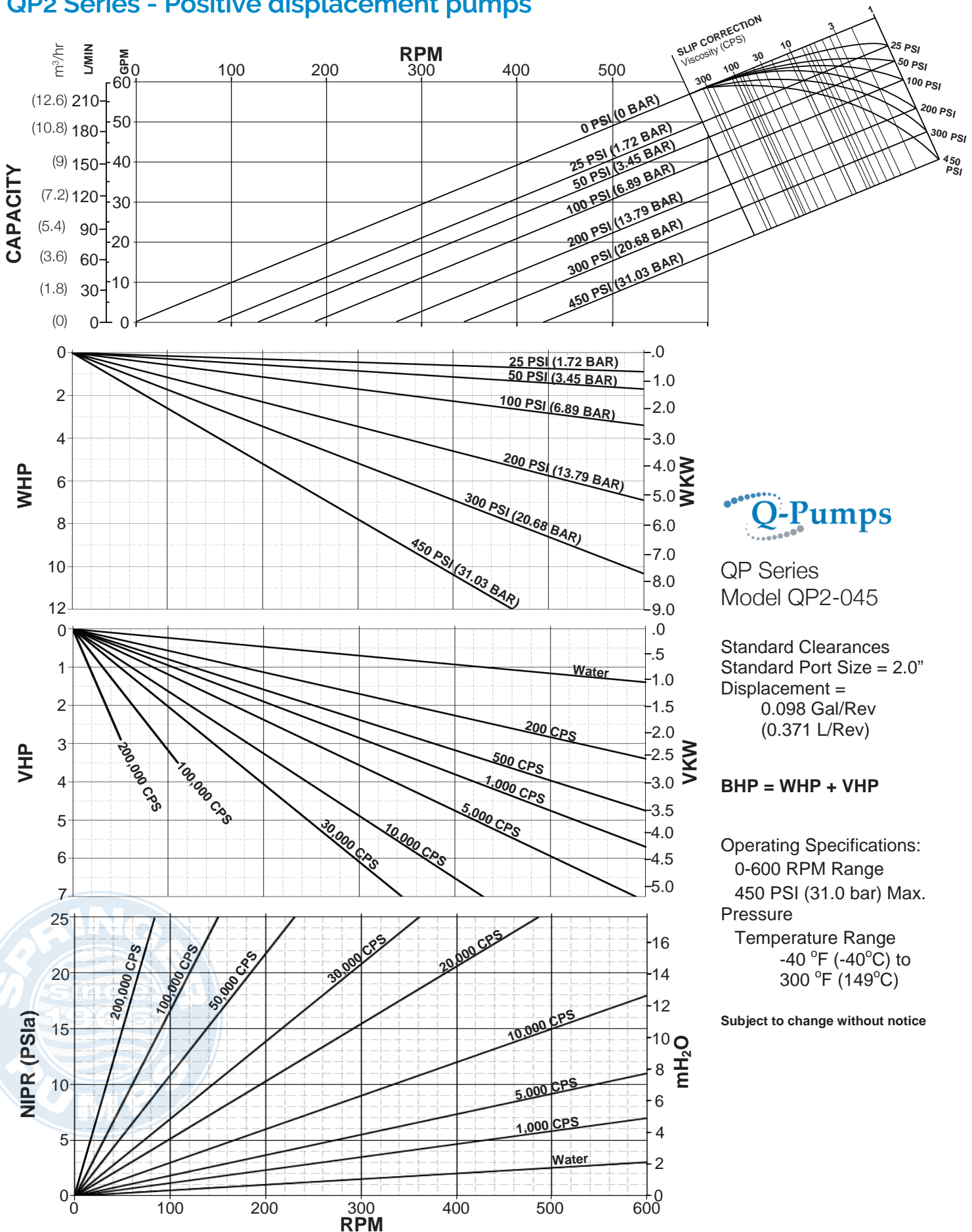

QP Series
Model QP2-045

Standard Clearances
Standard Port Size = 2.0"
Displacement =
0.098 Gal/Rev
(0.371 L/Rev)

BHP = WHP + VHP

Operating Specifications:
0-600 RPM Range
450 PSI (31.0 bar) Max. Pressure
Temperature Range
-40 °F (-40°C) to
300 °F (149°C)

Subject to change without notice

QP2 Series - Positive displacement pumps

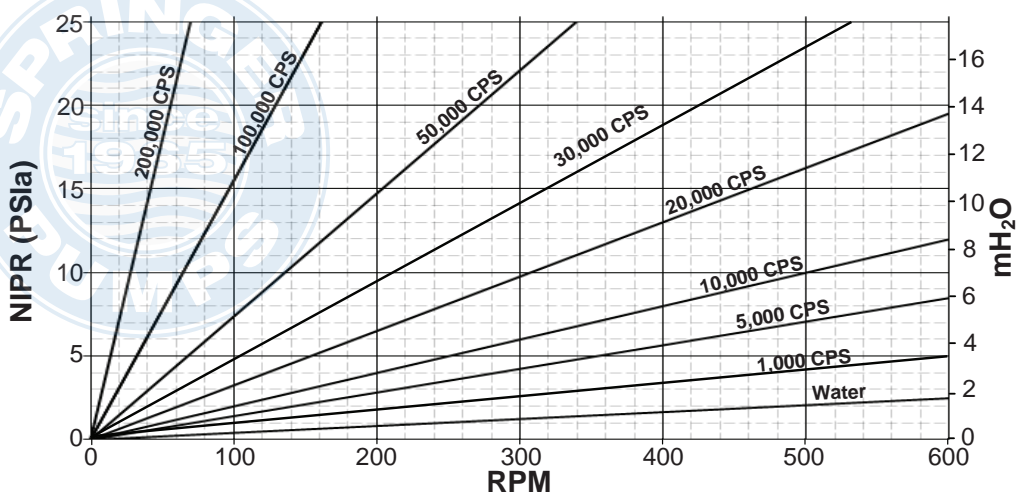
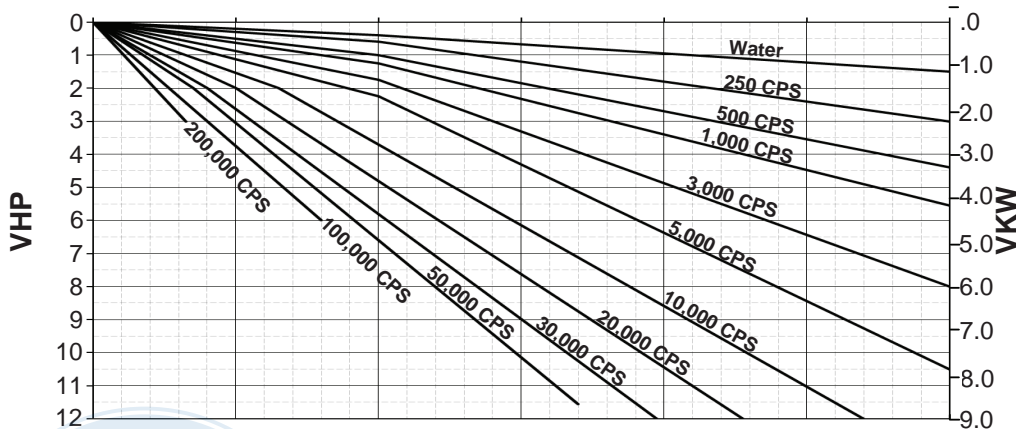
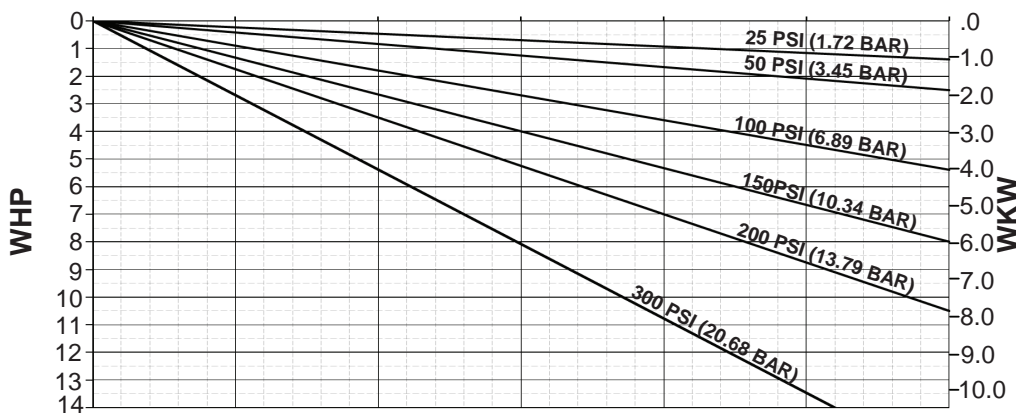
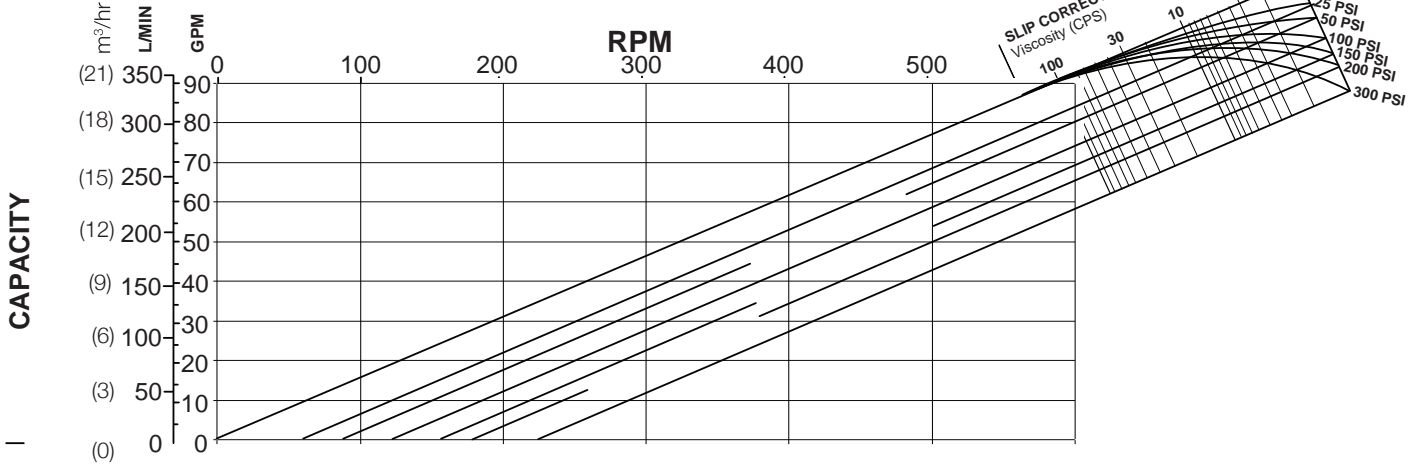

QP Series
Model QP2-060

Standard Clearances
Standard Port Size = 2.5"
Displacement =
0.153 Gal/Rev
(0.579 L/Rev)

BHP = WHP + VHP

Operating Specifications:
0-600 RPM Range
300 PSI (20.7 bar) Max. Pressure
Temperature Range
-40 °F (-40°C) to
300 °F (149°C)

Subject to change without notice

QP2 Series - Positive displacement pumps

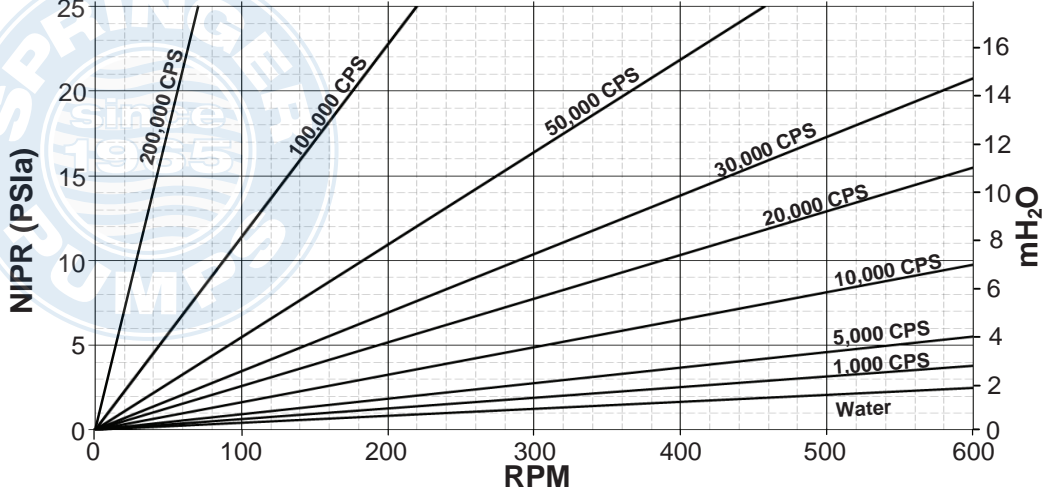
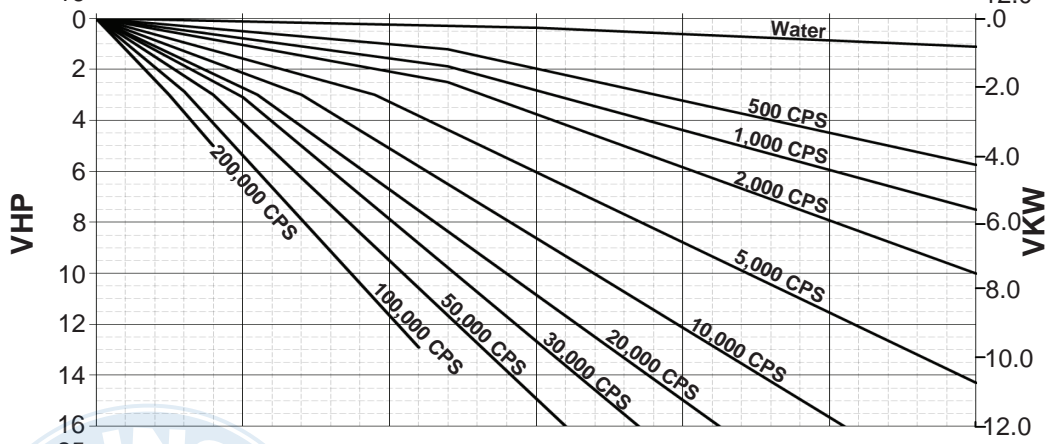
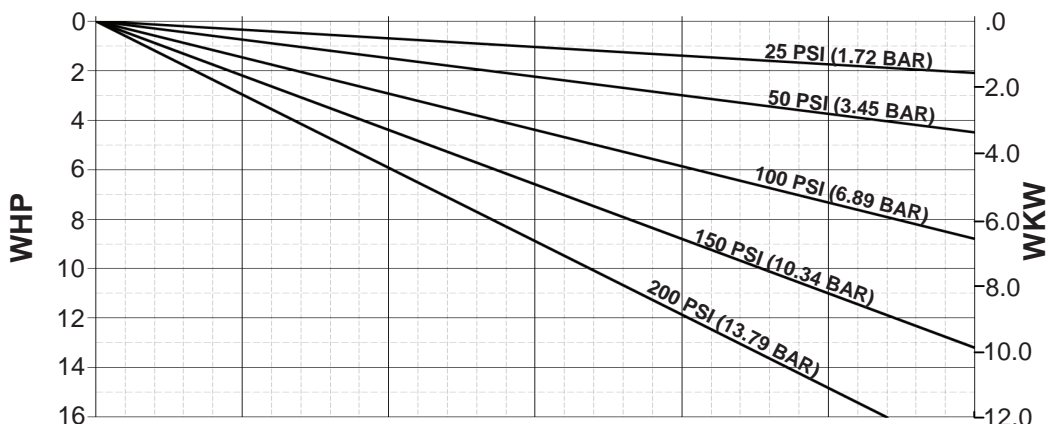
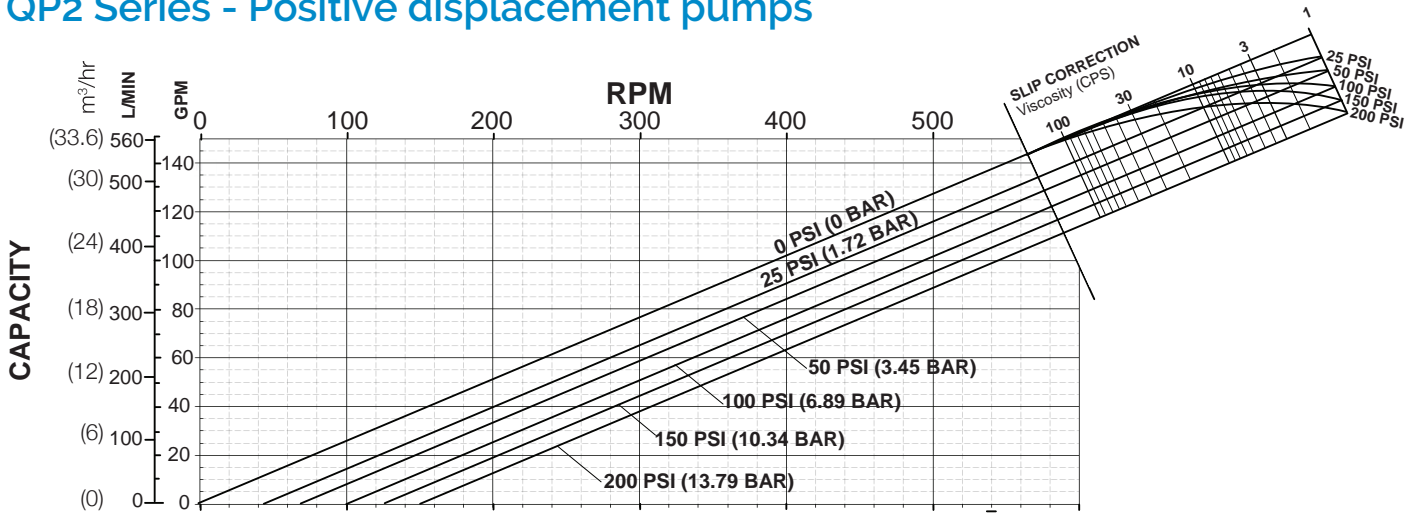

QP Series
Model QP2-130

Standard Clearances
Standard Port Size = 3.0"
Displacement =
0.253 Gal/Rev
(0.958 L/Rev)

BHP = WHP + VHP

Operating Specifications:
0-600 RPM Range
200 PSI (13.8 bar) Max. Pressure
Temperature Range
-40 °F (-40°C) to
300 °F (149°C)

Subject to change without notice

QP2 Series - Positive displacement pumps

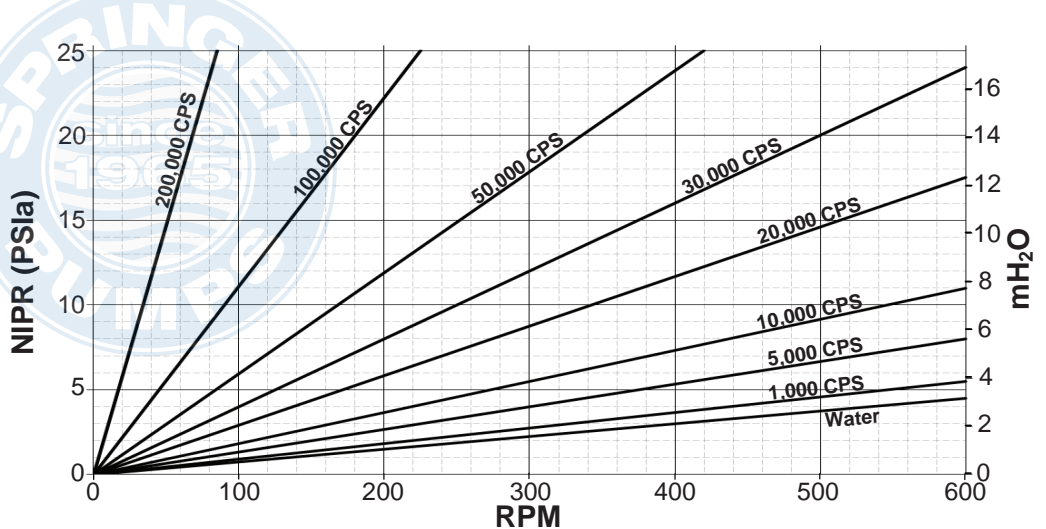
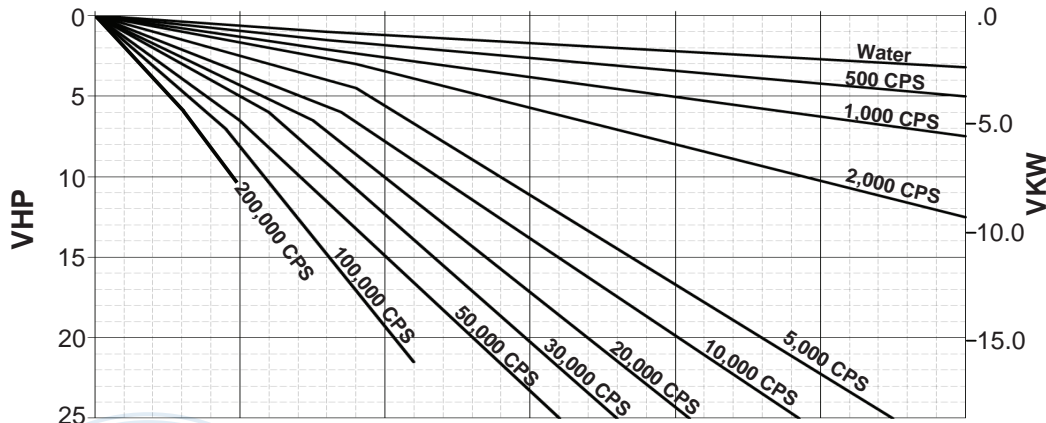
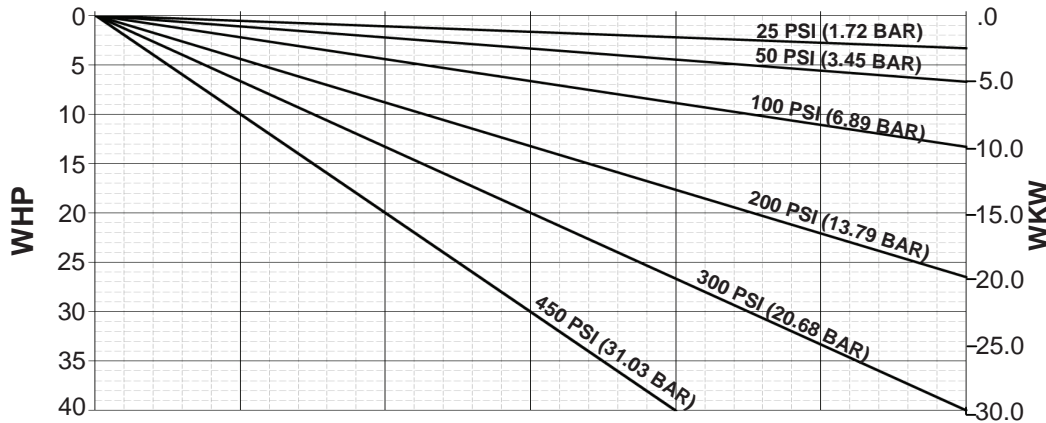
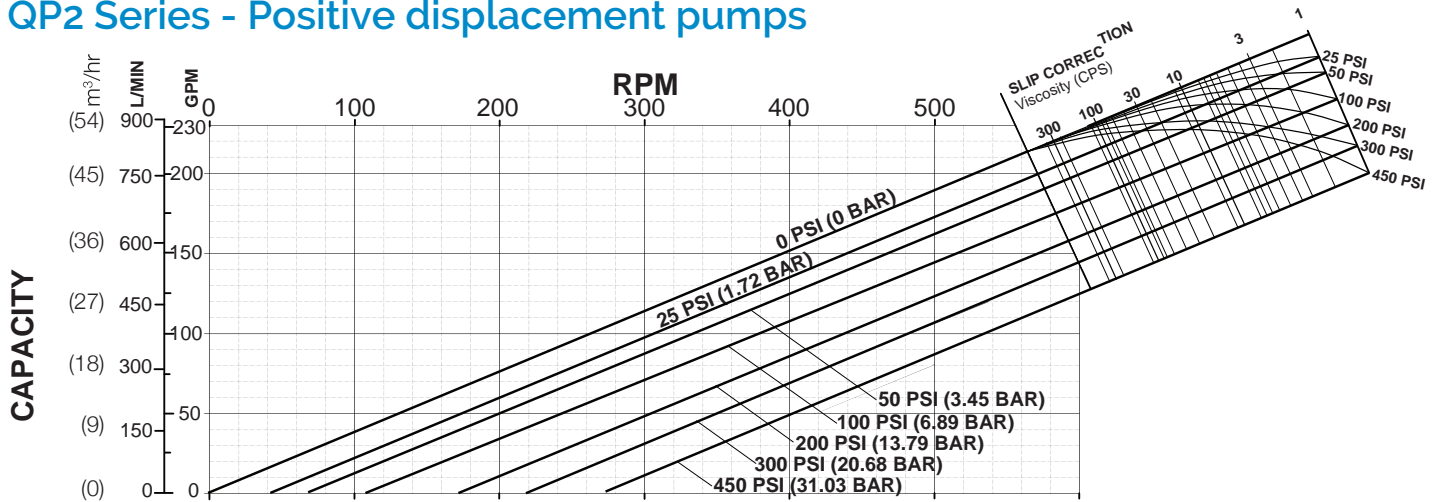

QP Series
Model QP2-180

Standard Clearances
Standard Port Size = 3.0"
Displacement =
0.380 Gal/Rev
(1.438 L/Rev)

BHP = WHP + VHP

Operating Specifications:
0-600 RPM Range
450 PSI (31.0 bar) Max. Pressure
Temperature Range
-40 °F (-40°C) to
300 °F (149°C)

Subject to change without notice

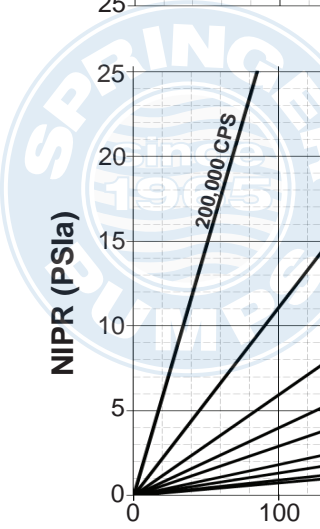

QP2 Series - Positive displacement pumps

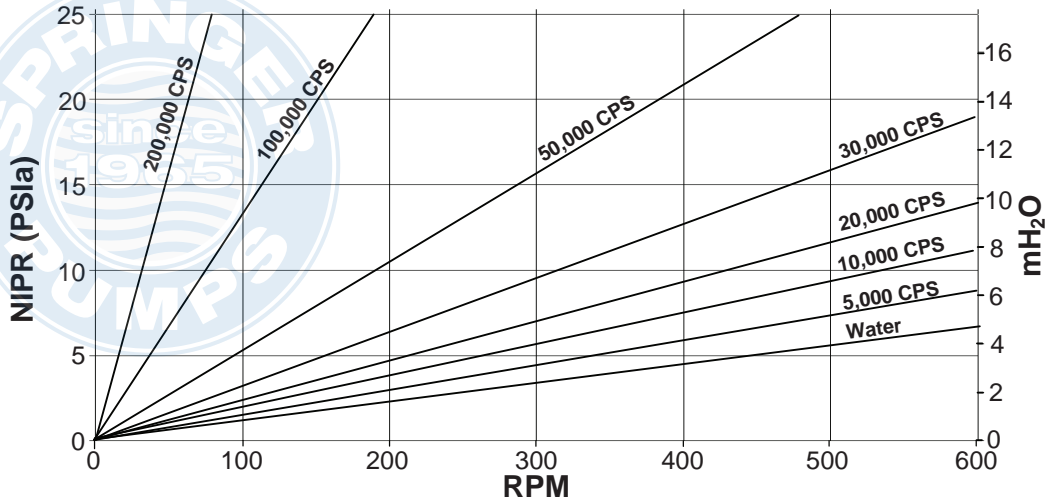
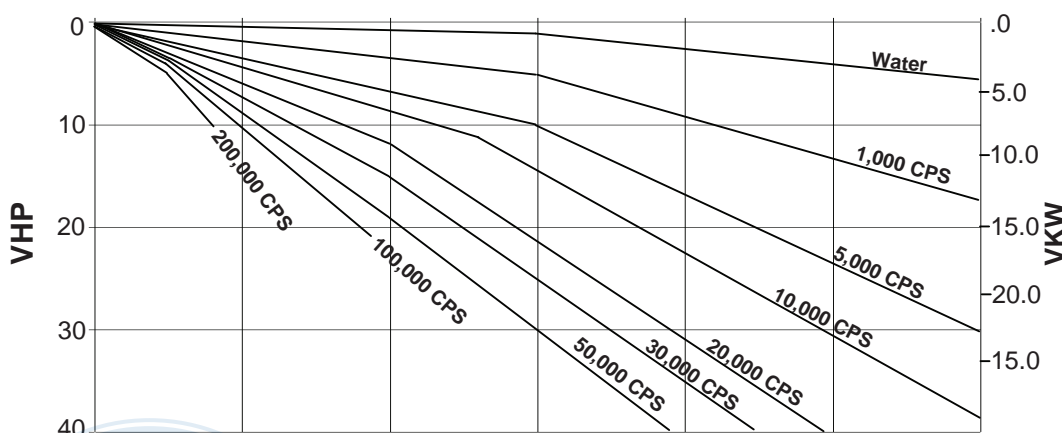
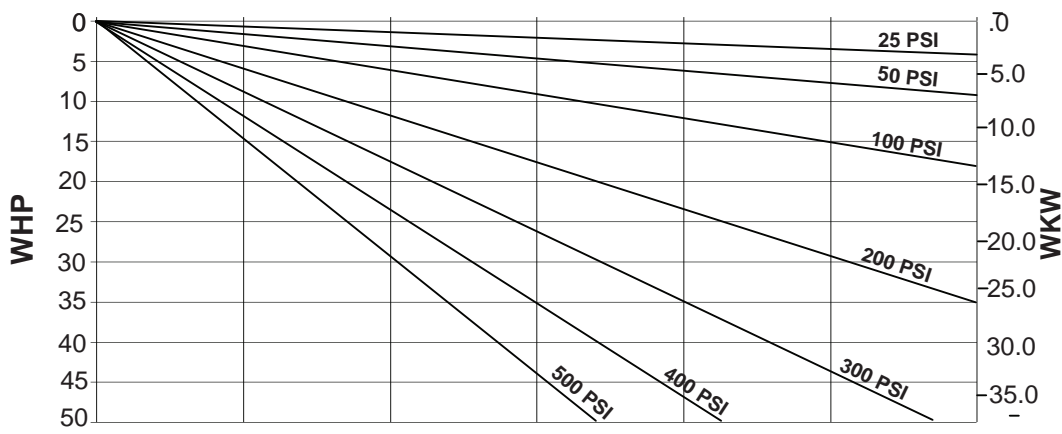
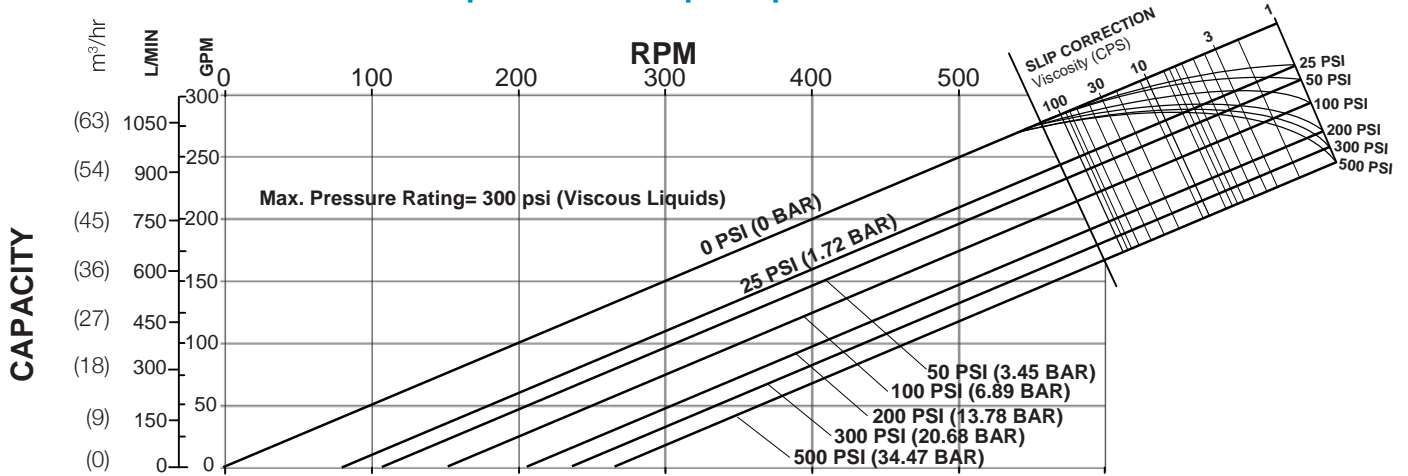

QP Series
Model QP2-210

Standard Clearances
Standard Port Size = 4.0"
Displacement =
0.502 Gal/Rev
(1.900 L/Rev)

BHP = WHP + VHP

Operating Specifications:
0-600 RPM Range
500 PSI (34.48 bar) Max. Pressure

Temperature Range
-40 °F (-40°C) to
300 °F (149°C)

Subject to change without notice

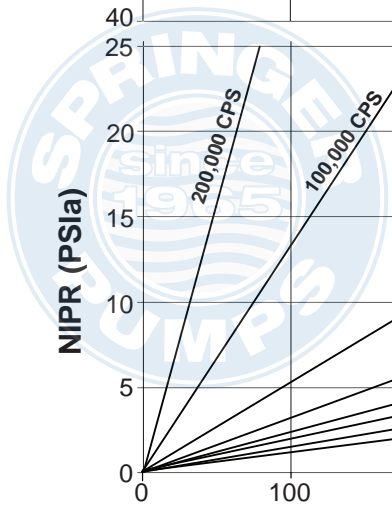

QP2 Series - Positive displacement pumps

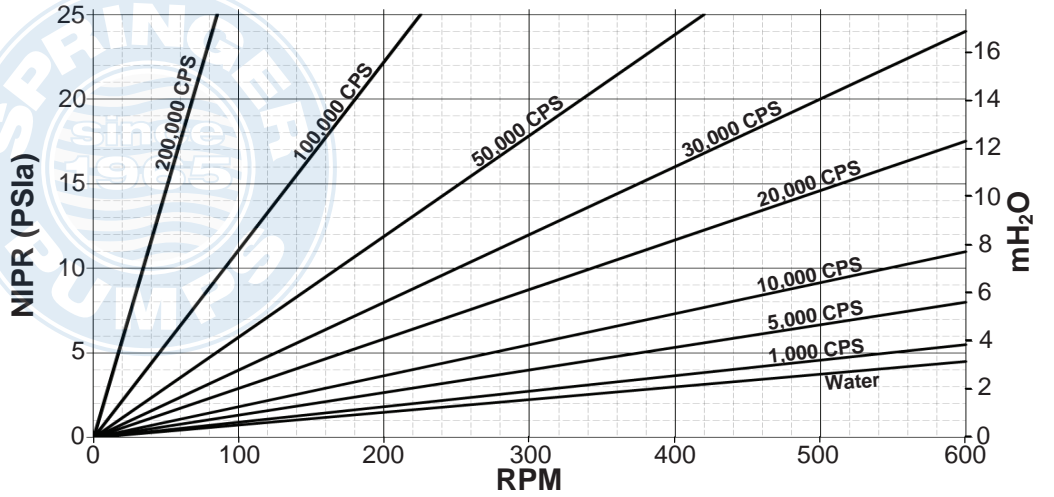
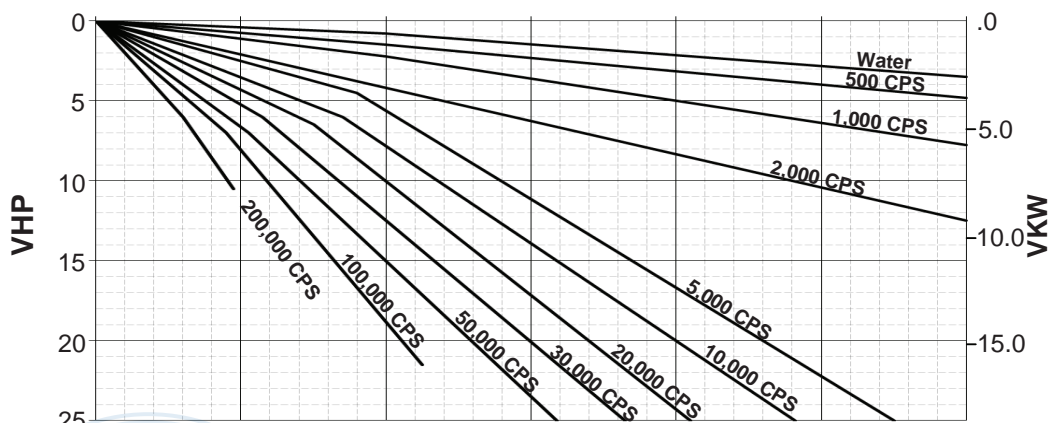
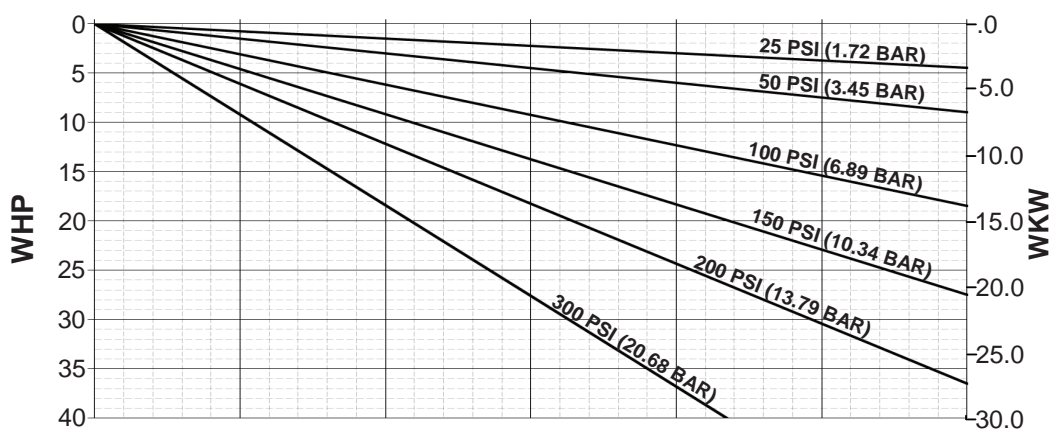
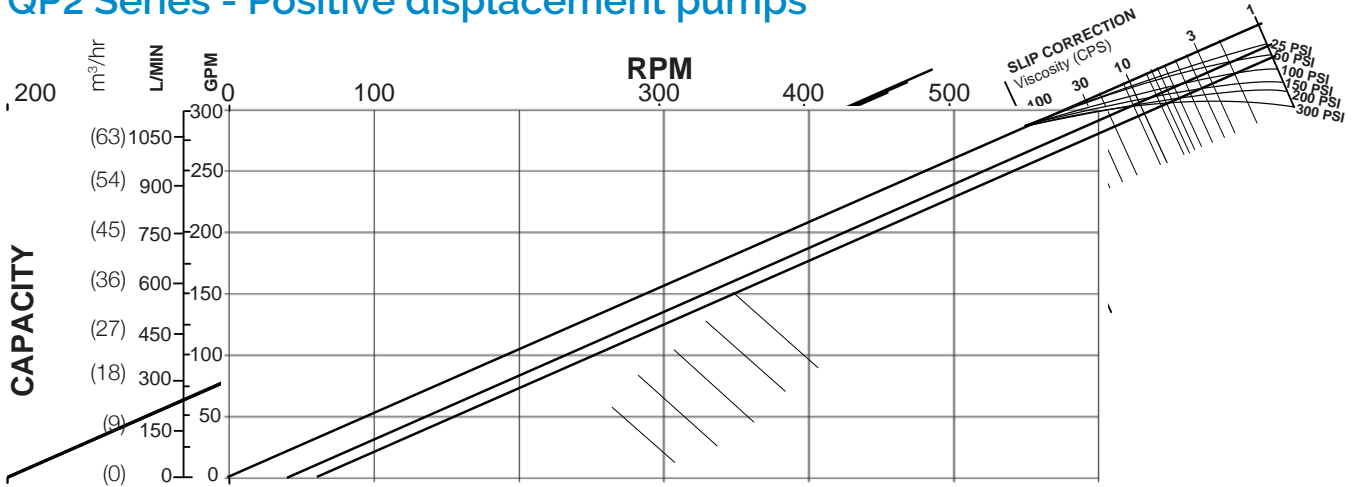

QP Series
Model QP2- 220

Standard Clearances
Standard Port Size = 4.0"
Displacement =
0.521 Gal/Rev
(1.972 L/Rev)

BHP = WHP + VHP

Operating Specifications:
0-600 RPM Range
300 PSI (20.68 bar) Max. Pressure
Temperature Range
-40 °F (-40°C) to
300 °F (149°C)

Subject to change without notice

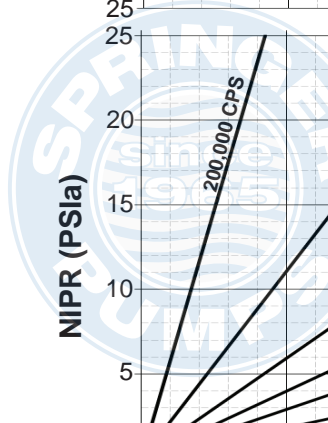

QP2 Series - Positive displacement pumps

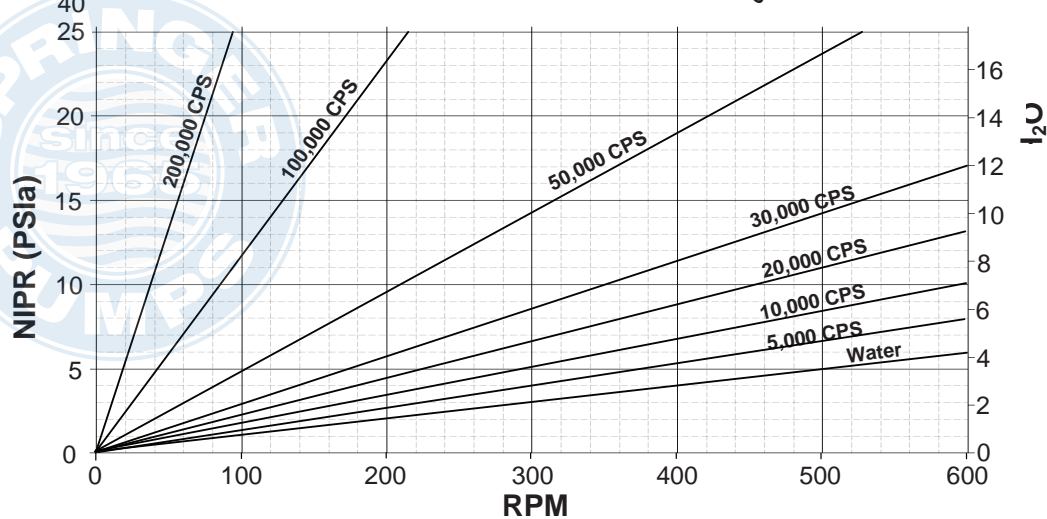
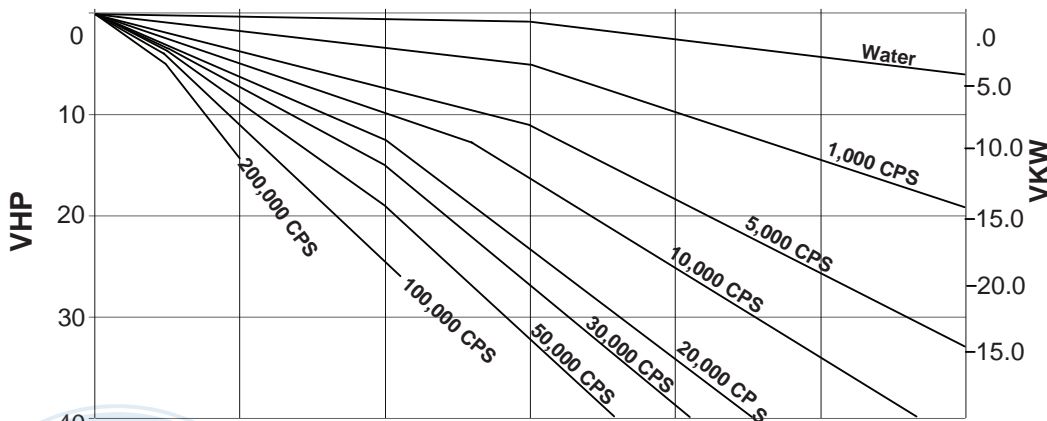
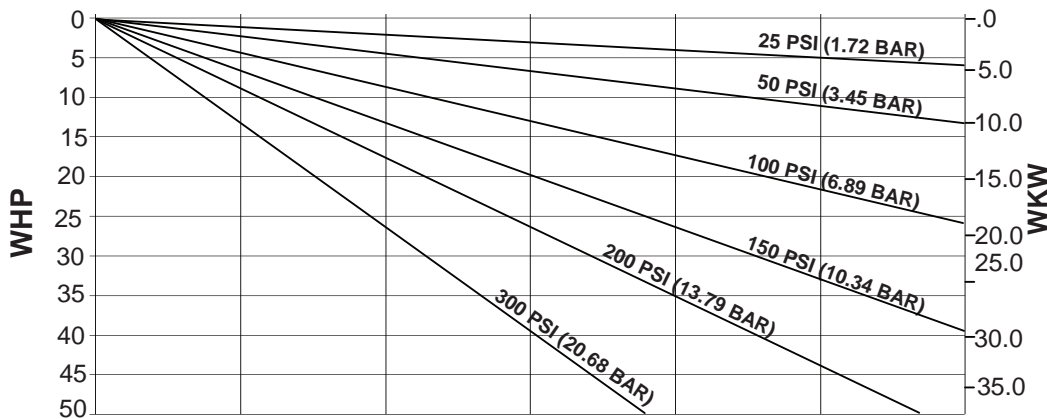
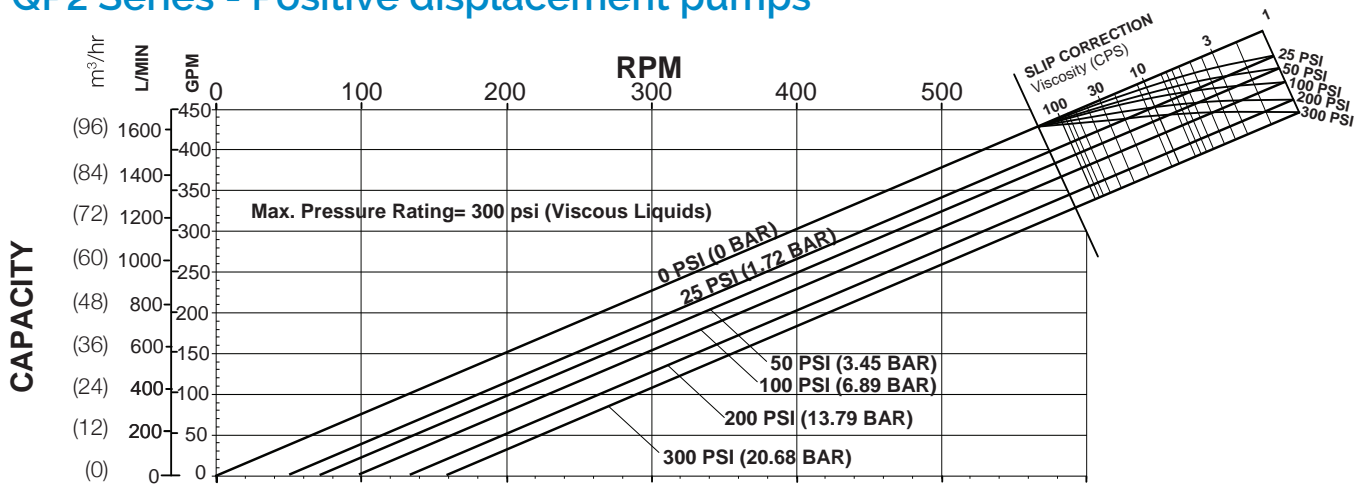

QP Series
Model QP2-320

Standard Clearances
Standard Port Size = 6.0"
Displacement =
0.720 Gal/Rev
(2.725 L/Rev)

BHP = WHP + VHP

Operating Specifications:
0-600 RPM Range
300 PSI (20.68 bar) Max. Pressure
Temperature Range
-40 °F (-40°C) to
300 °F (149°C)

Subject to change without notice

QP3 Series - Positive displacement pumps

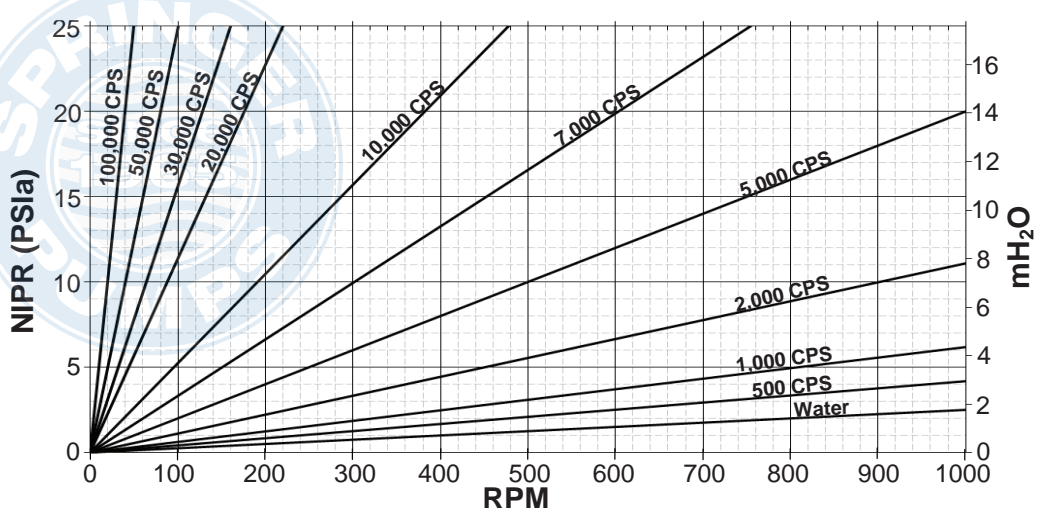
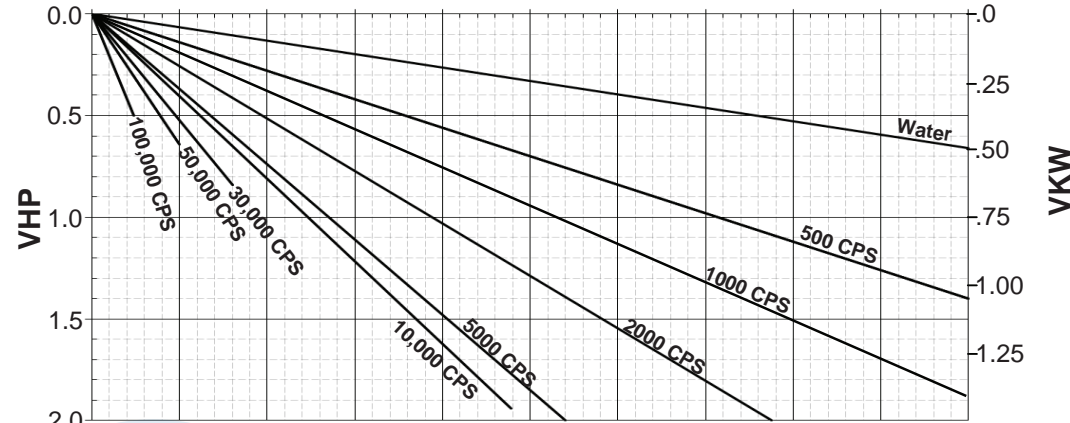
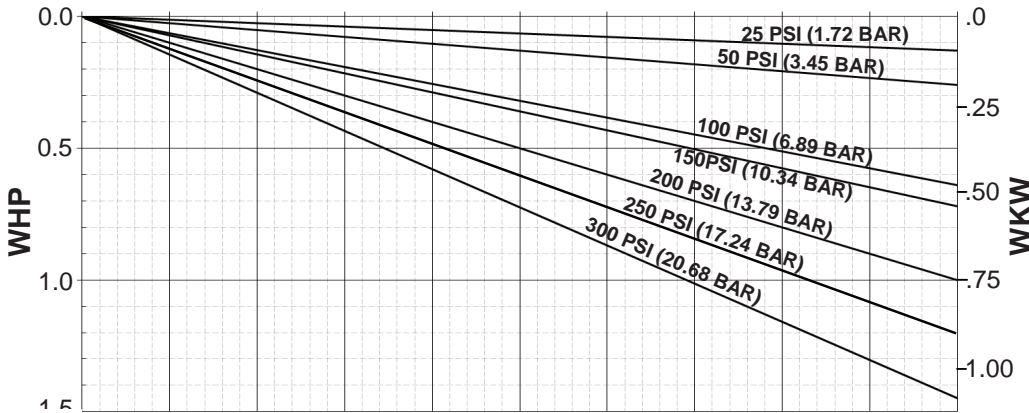
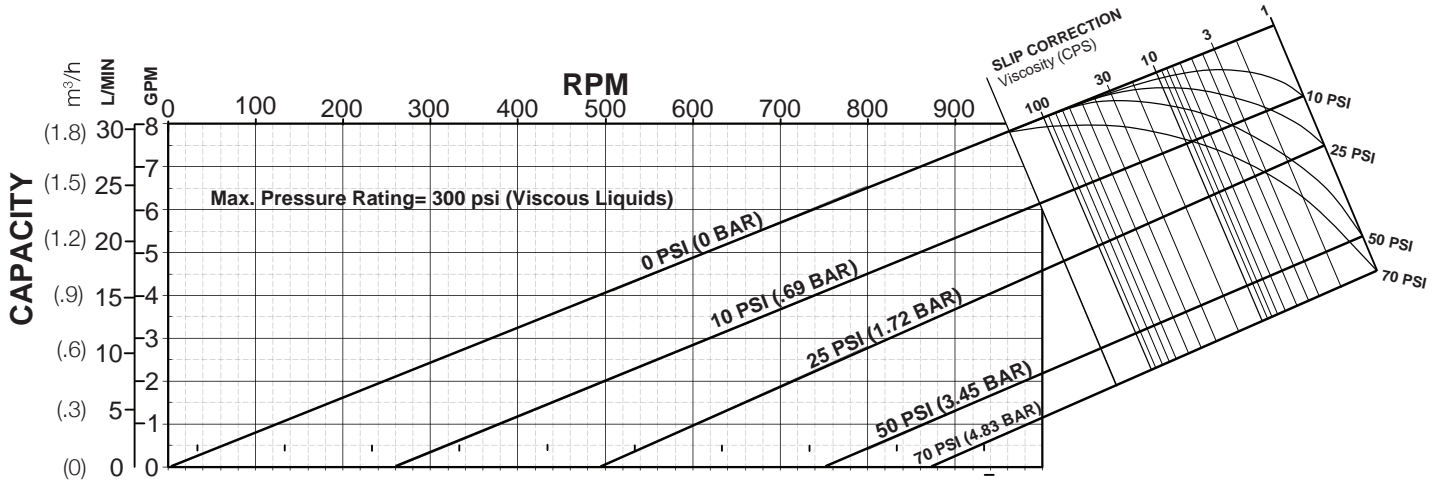

QP Series
Model QP3-006

Standard Clearances
Standard Port Size = 1.0"
Displacement =
0.008 Gal/Rev
(0.030 L/Rev)

BHP = WHP + VHP

Operating Specifications:
0-1000 RPM Range
300 PSI (20.7 bar) Max. Pressure
Temperature Range
-40 °F (-40°C) to
300 °F (149°C)

Subject to change without notice

QP3 Series - Positive displacement pumps

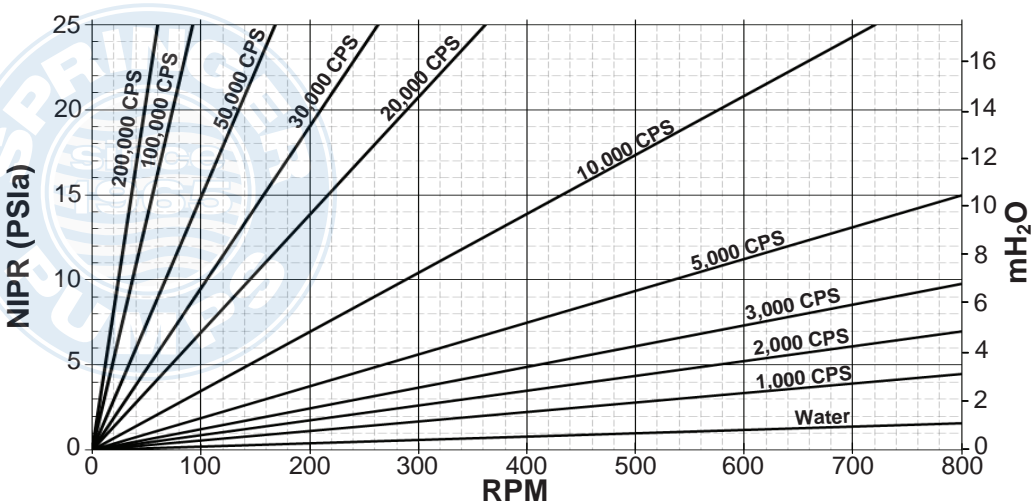
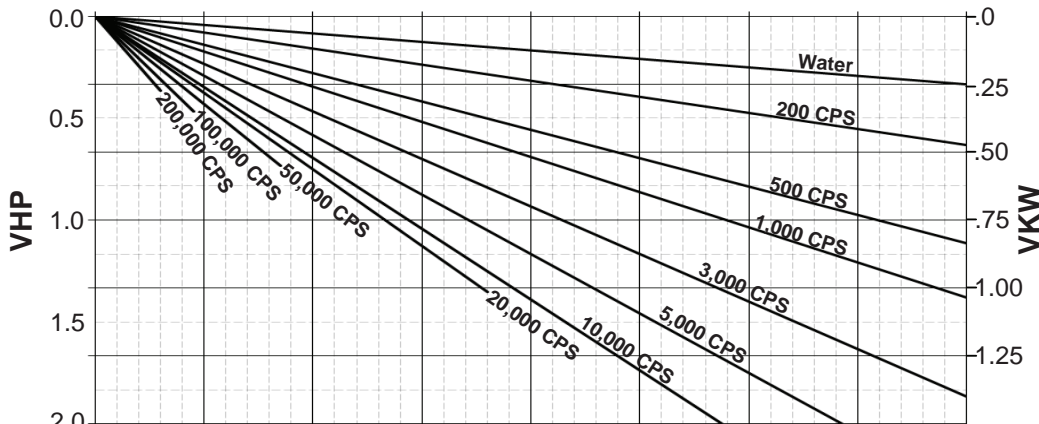
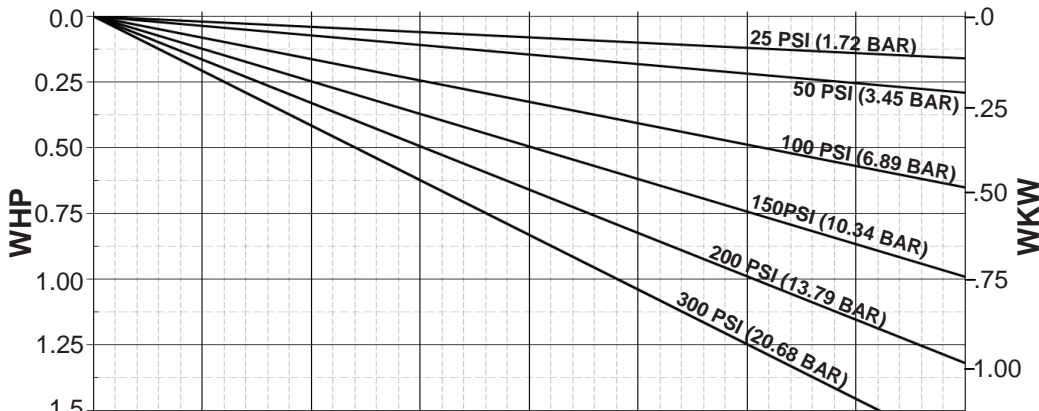
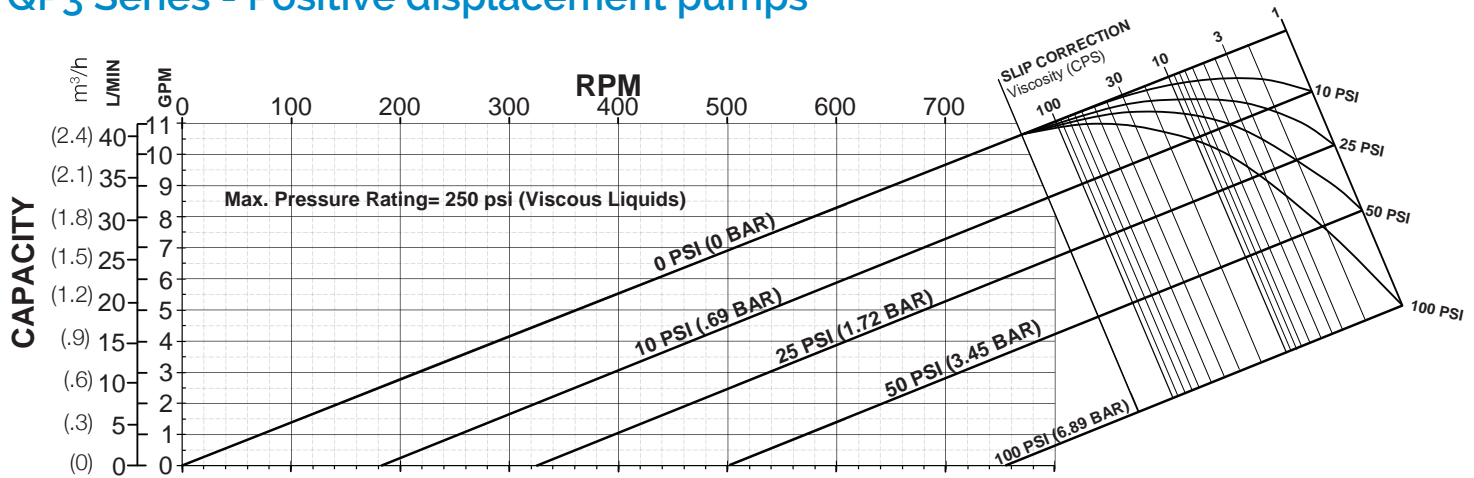

QP Series
Model QP3-015

Standard Clearances
Standard Port Size = 1.5"
Displacement =
0.014 Gal/Rev
(0.054 L/Rev)

BHP = WHP + VHP

Operating Specifications:
0-800 RPM Range
250 PSI (17.2 bar) Max. Pressure
Temperature Range
-40 °F (-40°C) to
300 °F (149°C)

Subject to change without notice

QP3 Series - Positive displacement pumps

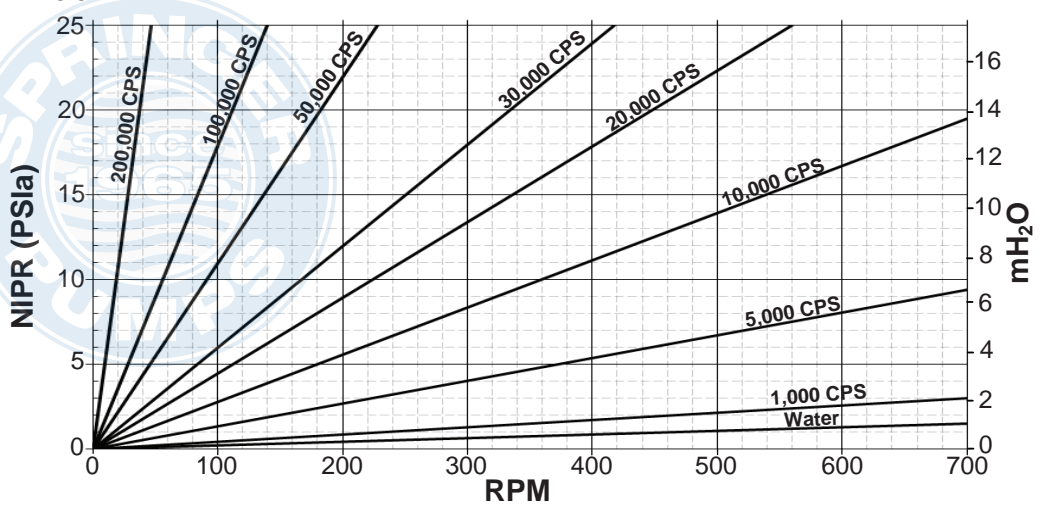
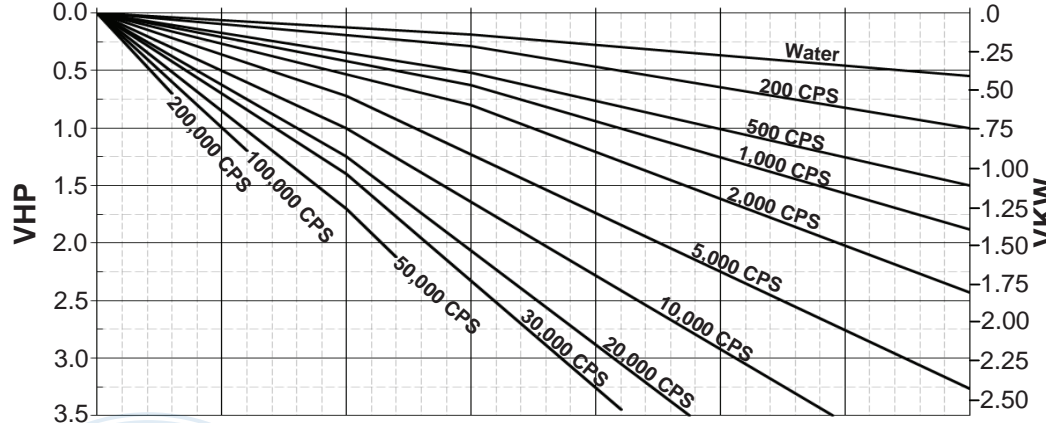
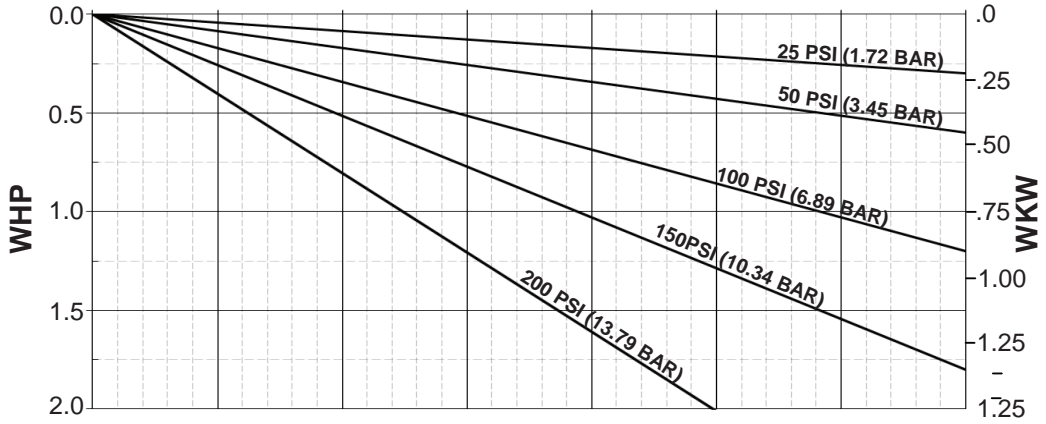
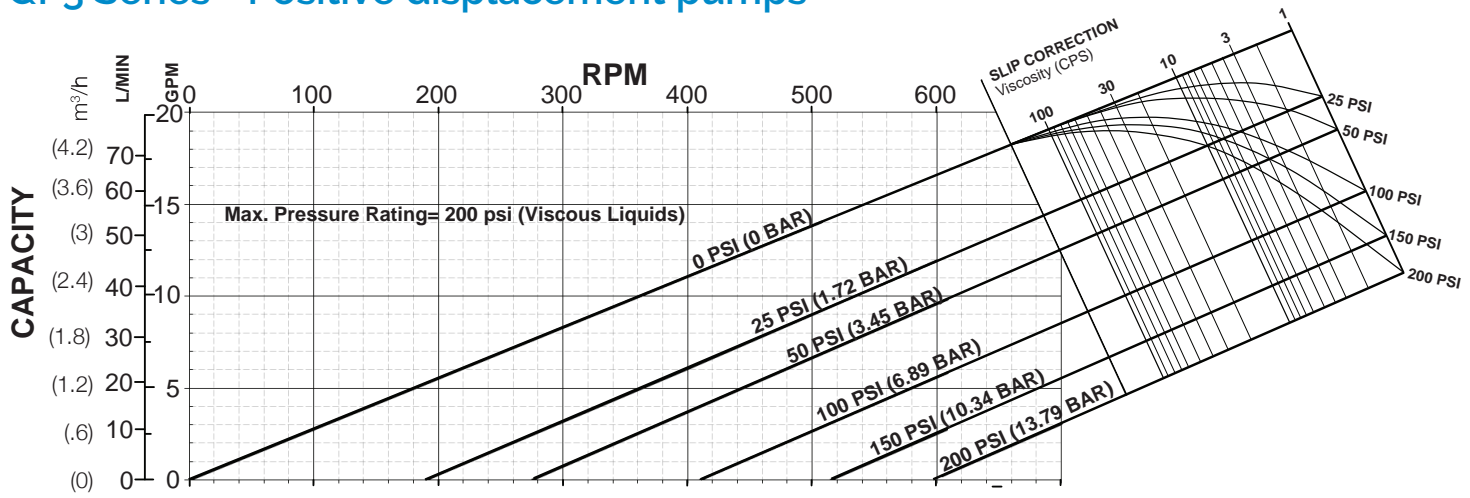

QP Series
Model QP3-018

Standard Clearances
Standard Port Size = 1.5"
Displacement =
0.029 Gal/Rev
(0.108 L/Rev)

BHP = WHP + VHP

Operating Specifications:
0-700 RPM Range
200 PSI (13.8 bar) Max. Pressure
Temperature Range
-40 °F (-40°C) to
300 °F (149°C)

Subject to change without notice

QP3 Series - Positive displacement pumps

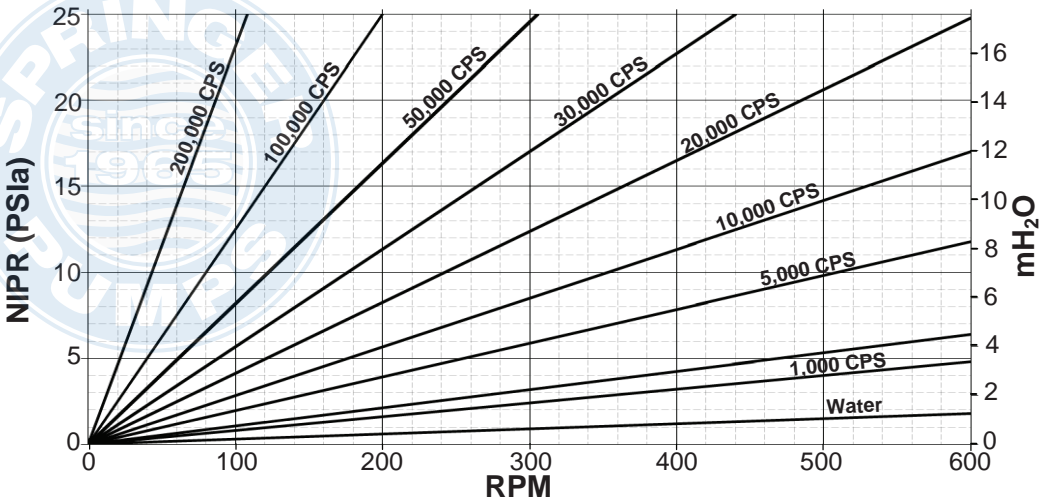
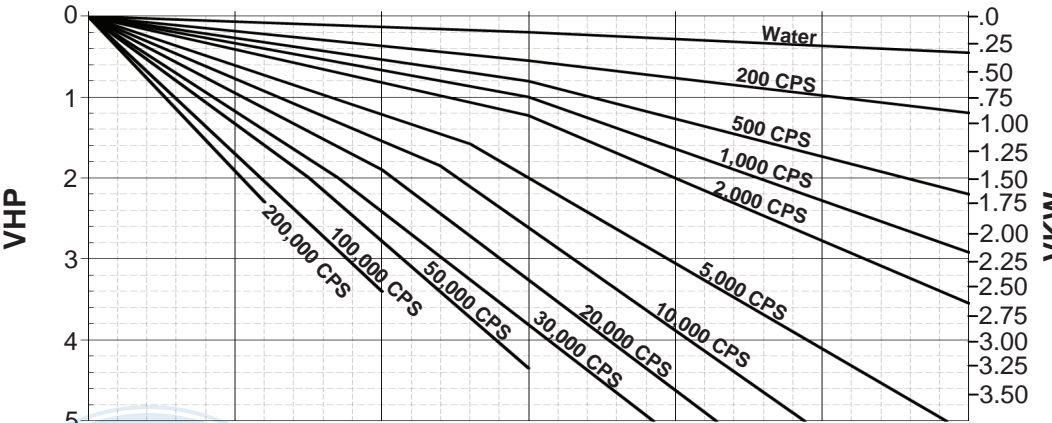
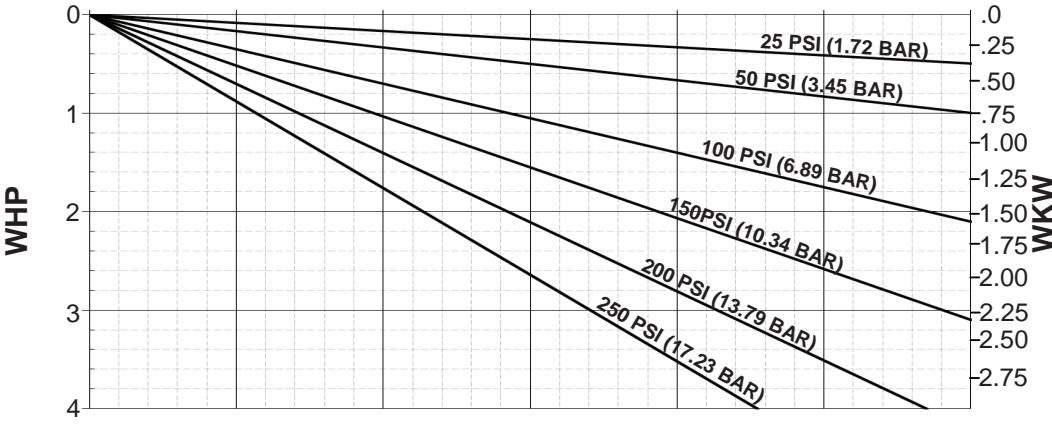
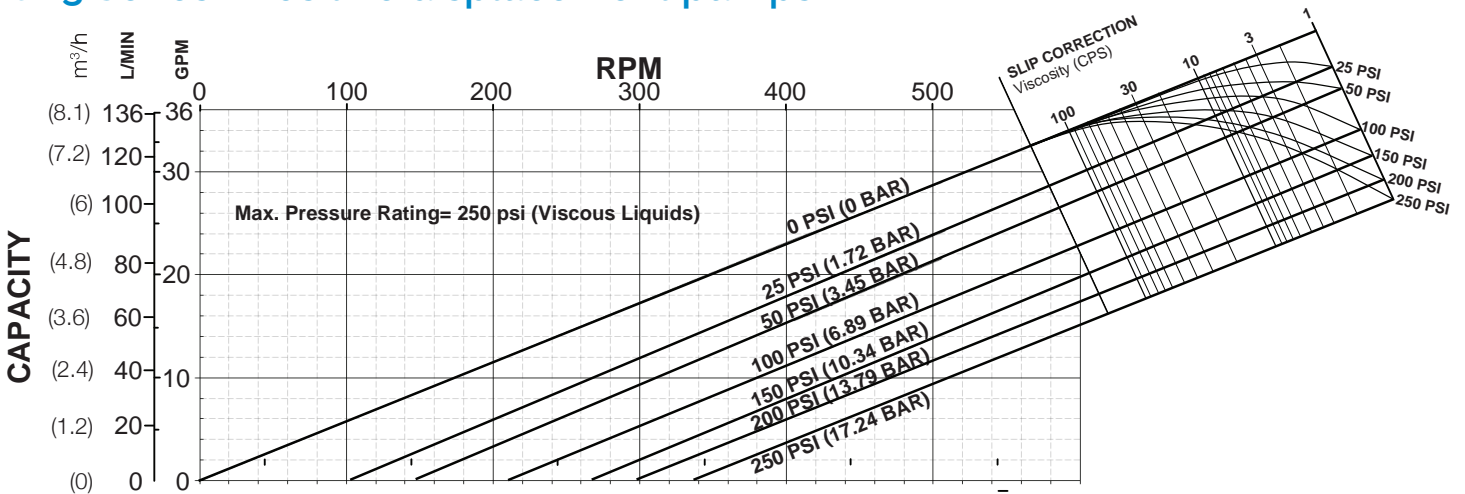

QP Series
Model QP3-030

Standard Clearances
Standard Port Size = 1.5"
Displacement =
0.060 Gal/Rev
(0.227 L/Rev)

BHP = WHP + VHP

Operating Specifications:
0-600 RPM Range
250 PSI (17.2 bar) Max. Pressure

Temperature Range
-40 °F (-40°C) to
300 °F (149°C)

Subject to change without notice

QP3 Series - Positive displacement pumps

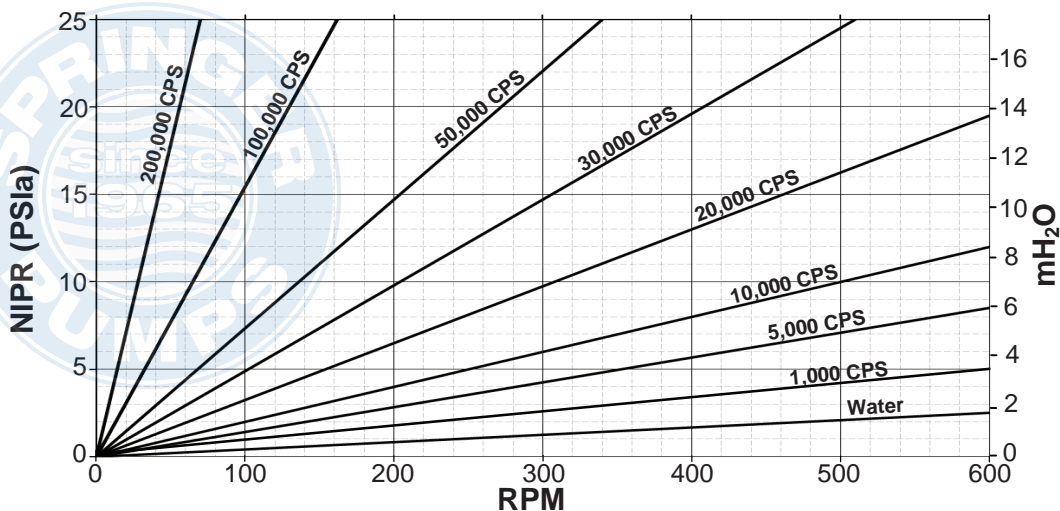
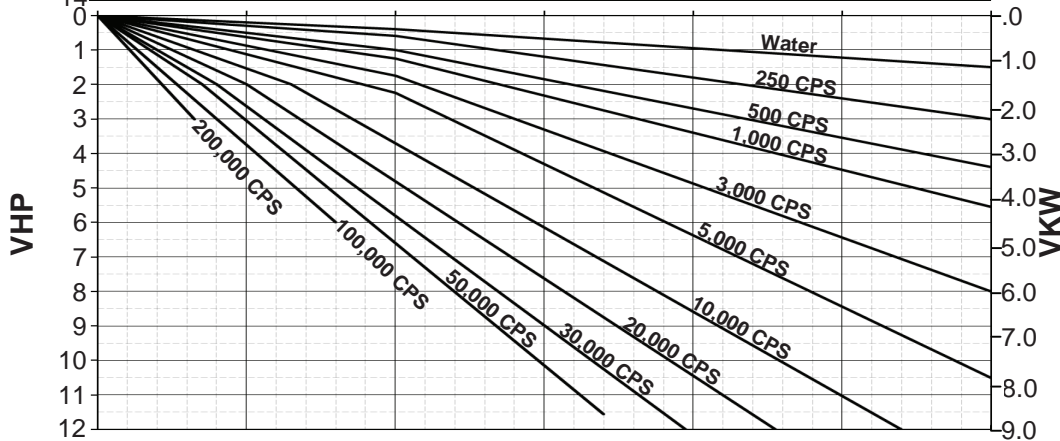
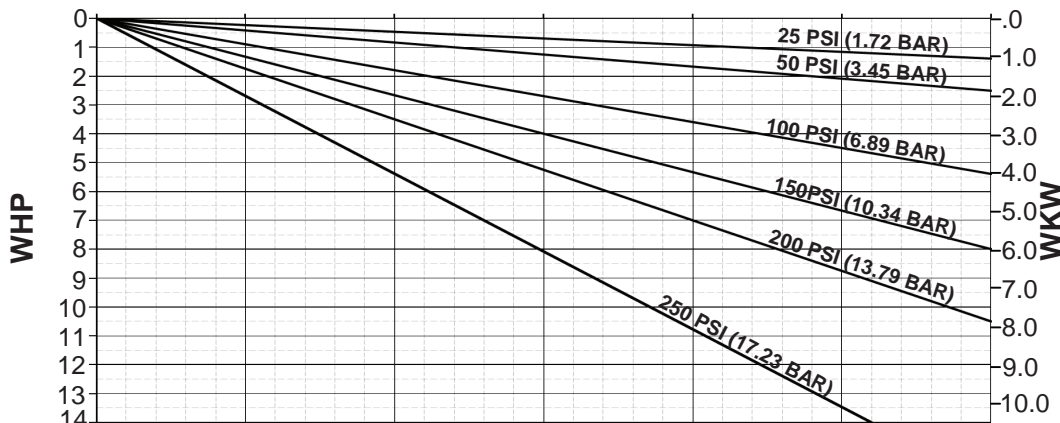
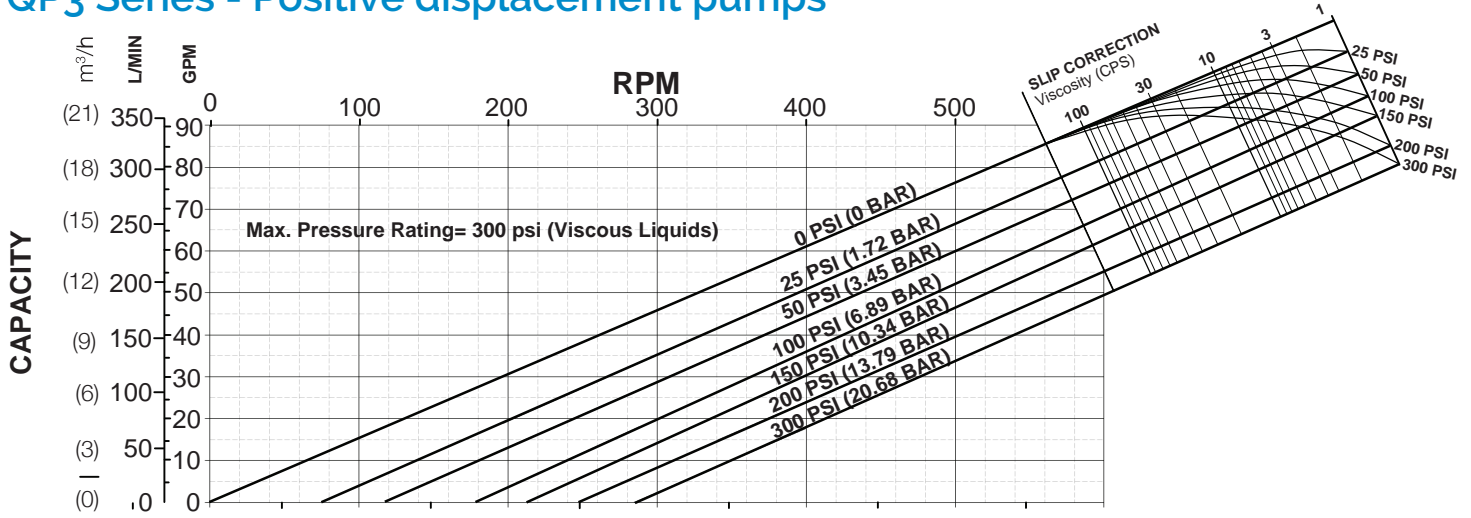

QP Series
Model QP3-060

Standard Clearances
Standard Port Size = 2.5"
Displacement =
0.153 Gal/Rev
(0.579 L/Rev)

BHP = WHP + VHP

Operating Specifications:
0-600 RPM Range
300 PSI (20.7 bar) Max. Pressure
Temperature Range
-40 °F (-40°C) to
300 °F (149°C)

Subject to change without notice

QP3 Series - Positive displacement pumps

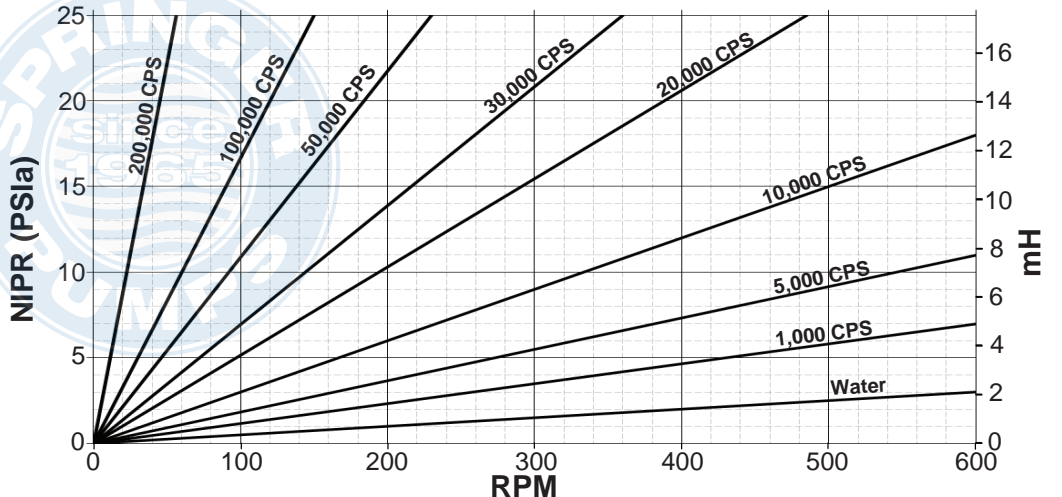
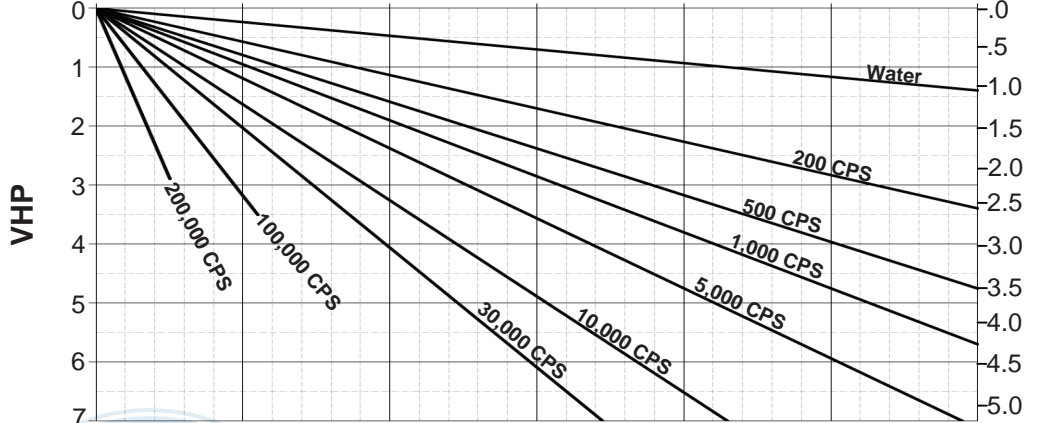
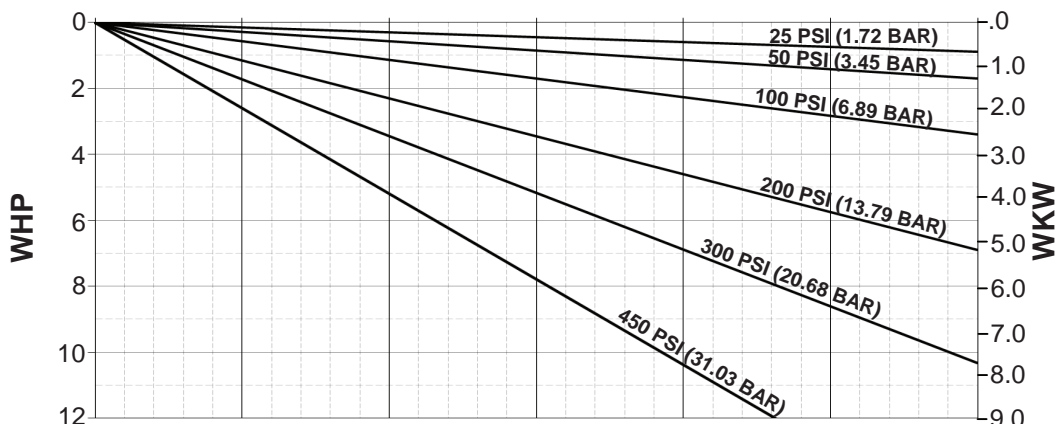
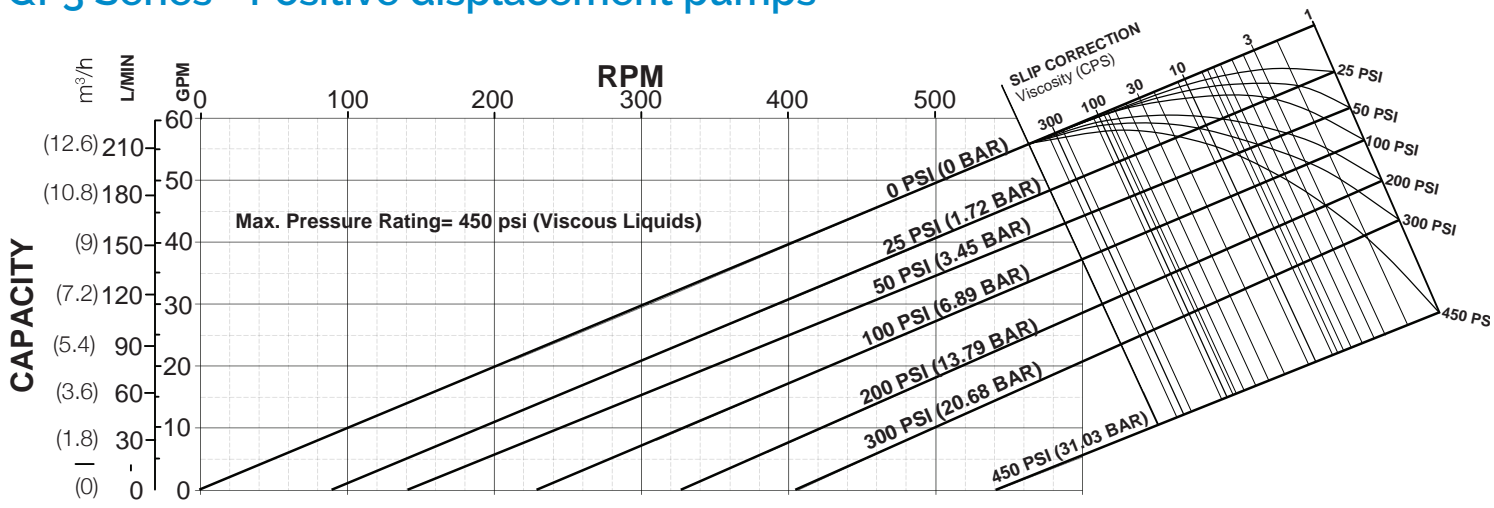

QP Series
Model QP3-045

Standard Clearances
Standard Port Size = 2.0"
Displacement =
0.098 Gal/Rev
(0.371 L/Rev)

BHP = WHP + VHP

Operating Specifications:
0-600 RPM Range
450 PSI (31.0 bar) Max. Pressure
Temperature Range
-40 °F (-40°C) to
300 °F (149°C)

Subject to change without notice

QP3 Series - Positive displacement pumps

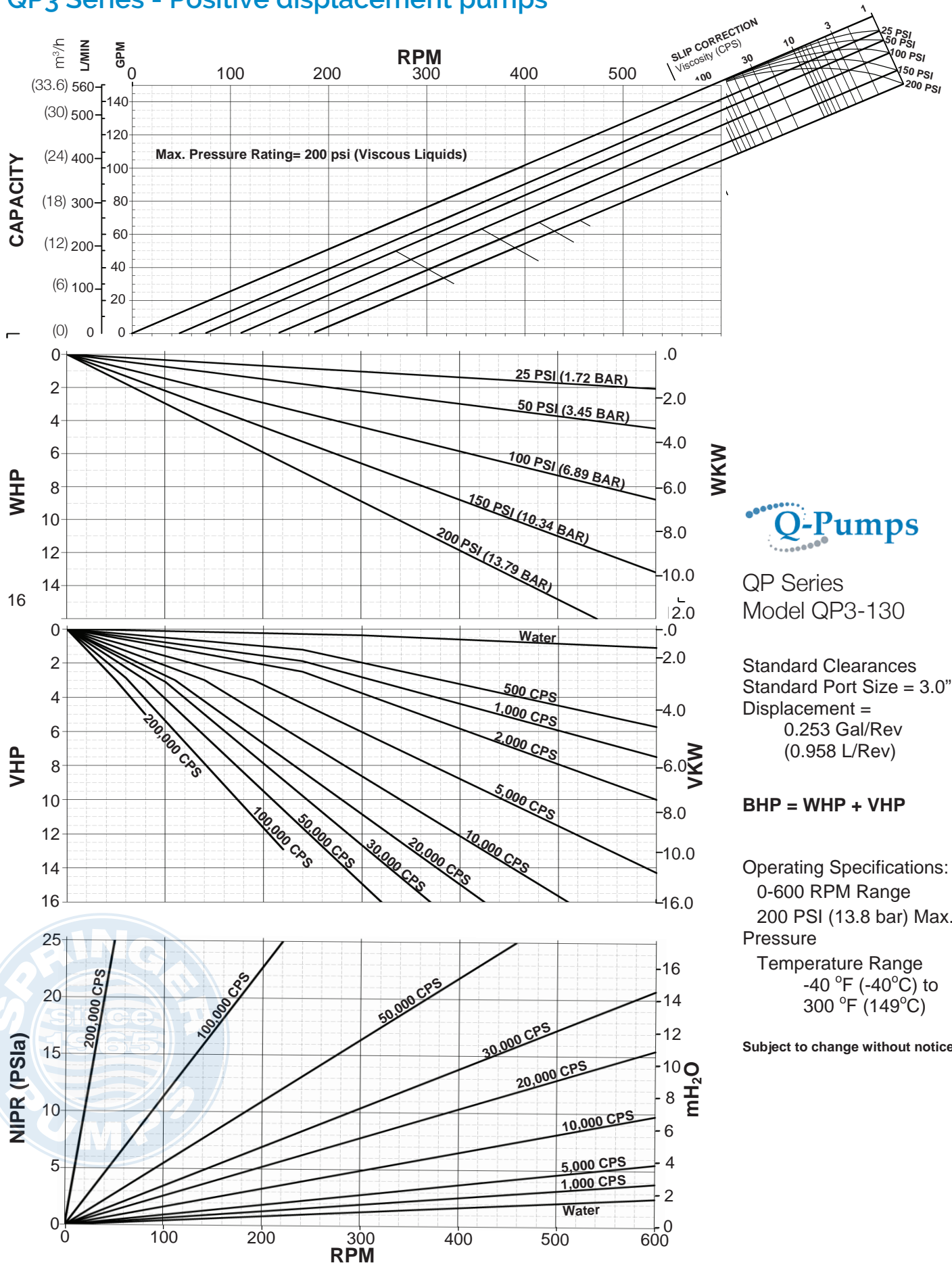

QP Series
Model QP3-130

Standard Clearances
Standard Port Size = 3.0"
Displacement =
0.253 Gal/Rev
(0.958 L/Rev)

BHP = WHP + VHP

Operating Specifications:
0-600 RPM Range
200 PSI (13.8 bar) Max. Pressure
Temperature Range
-40 °F (-40°C) to
300 °F (149°C)

Subject to change without notice

QP3 Series - Positive displacement pumps

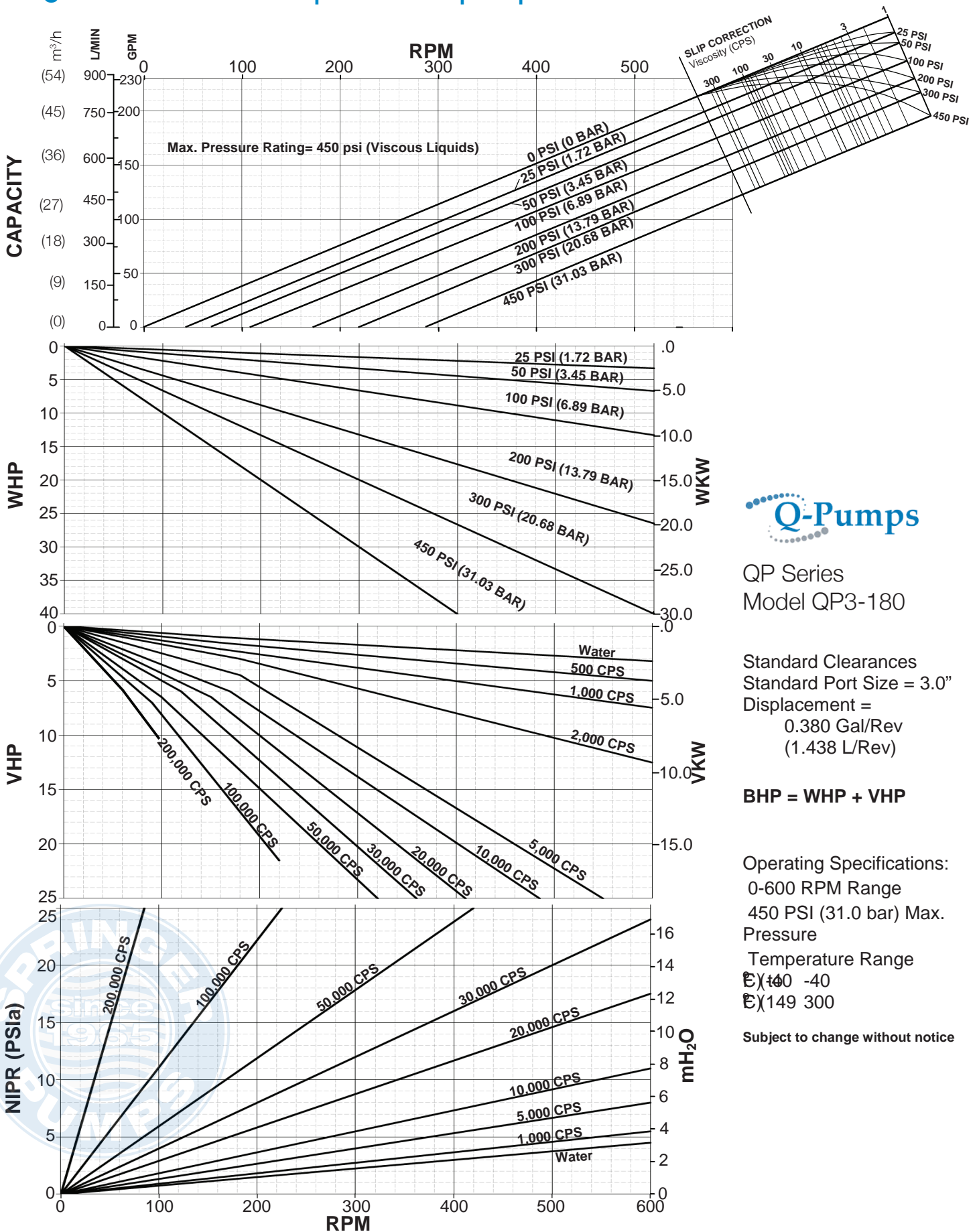

QP Series
Model QP3-180

Standard Clearances
Standard Port Size = 3.0"
Displacement =
0.380 Gal/Rev
(1.438 L/Rev)

BHP = WHP + VHP

Operating Specifications:
0-600 RPM Range
450 PSI (31.0 bar) Max. Pressure
Temperature Range
E) ±40 -40
E) 149 300

Subject to change without notice

QP3 Series - Positive displacement pumps

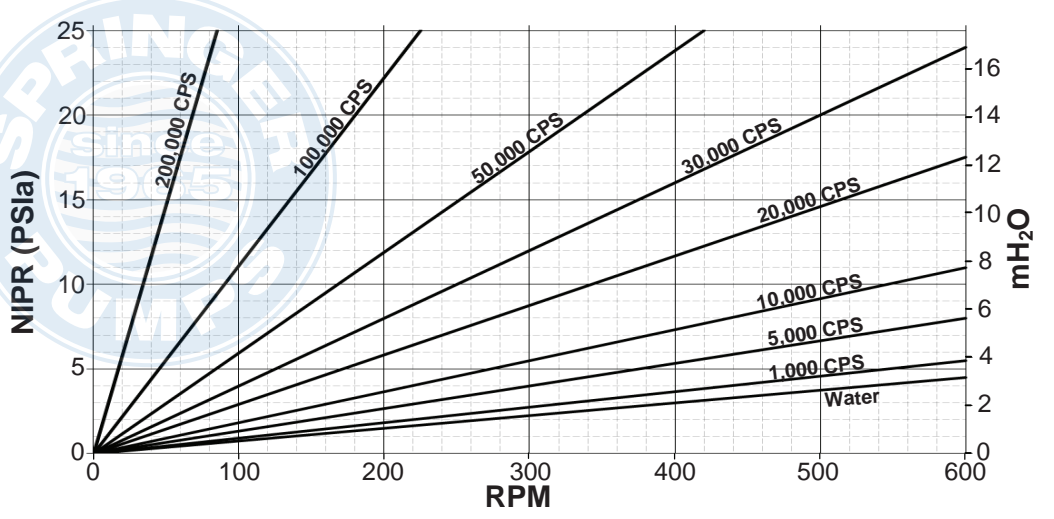
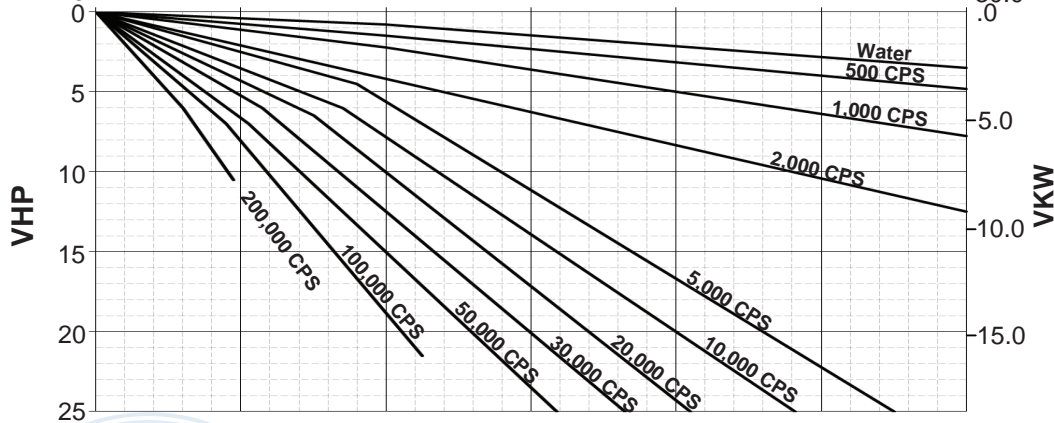
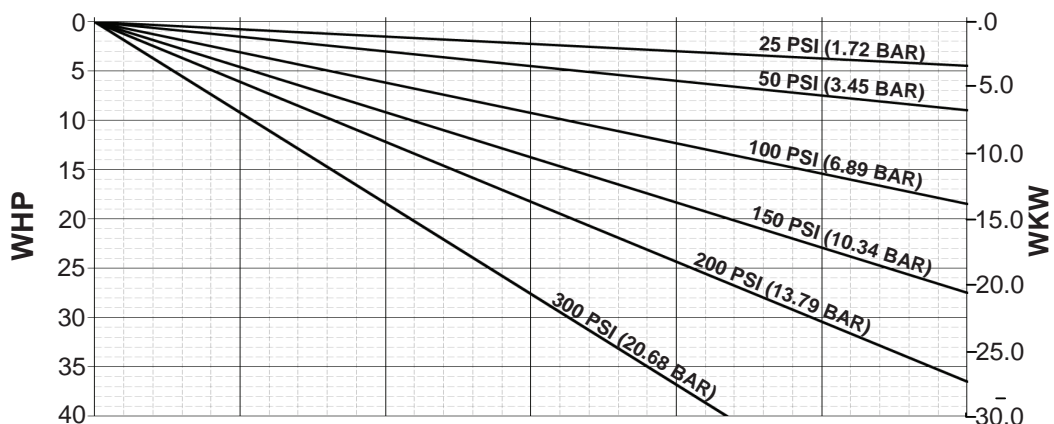
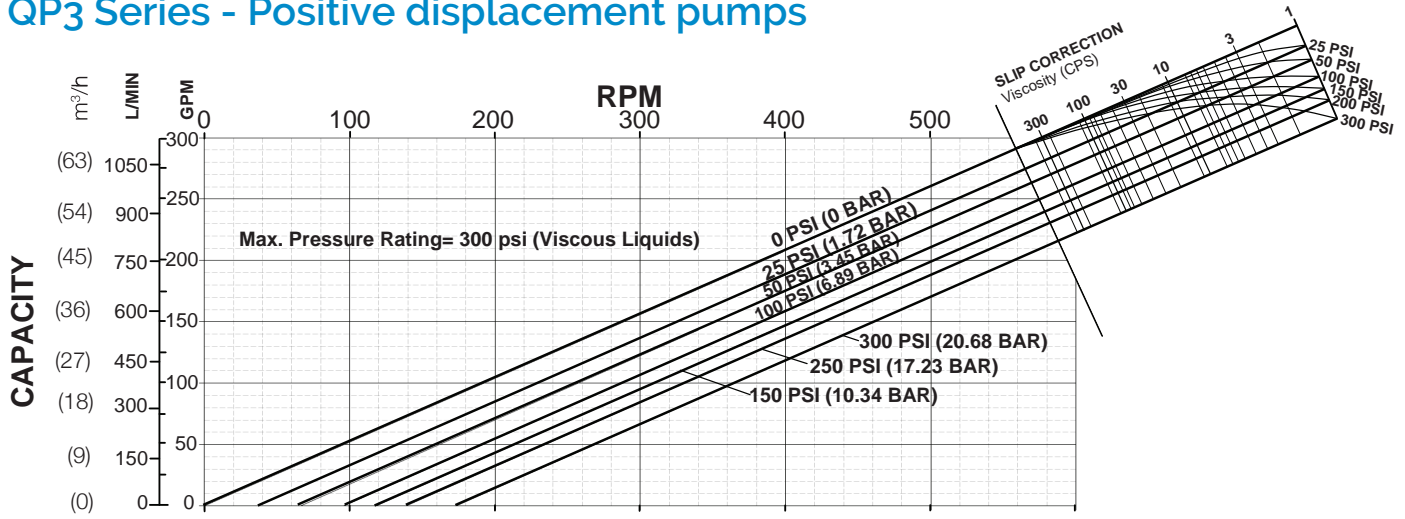

QP Series
Model QP3-220

Standard Clearances
Standard Port Size = 4.0"
Displacement =
0.521 Gal/Rev
(1.972 L/Rev)

BHP = WHP + VHP

Operating Specifications:
0-600 RPM Range
300 PSI (20.68 bar) Max. Pressure
Temperature Range
-40 °F (-40°C) to
300 °F (149°C)

Subject to change without notice

